

UDC 519.711.3 (045), DOI: 10.18372/1990-5548.51.11703

¹V. M. Sineglazov,
²V. A. Kopanev**SIMULATION MODELING OF SOLAR PLANTS WITH PHOTOELECTRIC CONVERTERS IN THE MODE OF SELECTION IN MAXIMUM POWER POINT IN MATLAB / SIMULINK**Educational & Research Institute of Information and Diagnostic Systems, National Aviation University,
Kyiv, UkraineE-mails: ¹svm@nau.edu.ua, ²tennobi@yandex.ru**Abstract**—The mathematical model for the study the operation of solar installation in the Matlab / Simulink environment is developed. The analysis of the results allows estimating the productivity of solar installations.**Index Terms**—Photovoltaic cells; photoelectric converter; mathematical model; volt-ampere characteristics; simulation modeling; solar installation.

I. INTRODUCTION

Solar energy is growing rapidly worldwide. Along with small installations (up to 10 kW), designed to power the local remote objects are operational photovoltaic solar power plant (PVPP) with a capacity of over 1 Mw, connected to the centralized electro supply networks.

According to [1] the average annual growth rate of power PVPP in the world for a period of five years 2007–2012 amounted to 60%. In the year 2012, the aggregate installed capacity of solar PV systems in the world amounted to more than 100 GW. Solar energy leaders have become such countries as Germany, China, Italy, Japan, and United States.

With regard to the manufacture of solar batteries, until recently, it was mainly concentrated in Europe, Japan and America. Over the past few years, substantially increased its production capacity in China. With increased demand for solar cells and modules, domestic producers are also increasing output.

In connection with the increasing volumes of release and commercialization of solar photovoltaic cells (PV) there is a need for a precise definition of their parameters and characteristics. Measurement of current-voltage characteristics (I-V) is the primary method of assessing the quality and performance of solar cells and modules. When researching PV the stage of direct measurement of I-V and Volt-watt characteristic (P-V curve) can be replaced by computer modeling process that eliminates the need to have expensive simulators solar radiation [2].

The task of developing, using modern simulation software of mathematical models of systems of power supply based on renewable energy systems is relevant. Such models will produce a comparative analysis of the options for building systems, as well as to optimize the parameters and modes of their operation.

II. PROBLEM STATEMENT

Based on known technical characteristics of solar modules (idling voltage and short-circuit current) to build a mathematical simulation model in Matlab/Simulink environment for withdrawing current-voltage and Volt-Watt characteristics under different levels of illumination. The results compare with the real current-voltage characteristics provided by the manufacturer.

III. RESEARCH METHOD

When researching the characteristics of photovoltaic cells used the method of mathematical simulation using Matlab/Simulink environment.

Mathematical description of PV: solar photovoltaic modules (SM) and solar photovoltaics panels consists of many individual solar photovoltaic cells (PVcells), which are connected serially and in parallel with the aim of achieving the required output voltage and current values. According to [3] solar photoelectric cell – solar cell based on the photoelectric effect, which converts the energy of sunlight into electrical energy. Effect of solar cells based on internal photoelectric effect [4]. It is the inner photoelectric effect, but rather the process of separating light quanta generated electron-hole pairs in the *p-n* junction lies at the heart of the process of generation of electric current in the solar photo cells.

Today the most common solar panels based on mono- and multicrystalline silicon, which accounted for about 80% of the world market. While intensively new innovative production technologies of various types of thin-film solar cells.

Solar photovoltaic cells can be represented as a functional unit having external, internal and output parameters (Fig. 1). To external parameters include the illumination of PVcells (*G*) and temperature (*T*). Internal parameters include idling voltage (U_{iv}) and the short-circuit current ($I_{pv\ cells}$). Output set-

tings-output voltage (U) load current (I) and power output (P) [5].

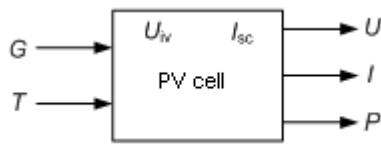

Fig. 1. Solar cell as a functional block

The main characteristic of solar cell (module) is a I-V dependency between the shock load and voltage at the terminals of the PV at constant temperature and intensity of incoming solar radiation. In determining the I-V of PV important factors are the intensity of the solar radiation and temperature. For measuring the intensity of solar radiation (W/m^2) using special devices. Fig. 2 presents the concept of withdrawing I-V of PV.

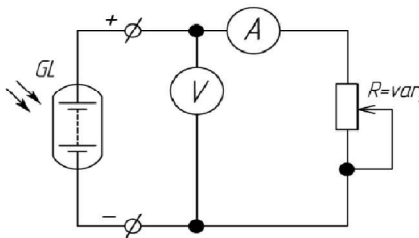

Fig. 2. PV cell schematic diagram of withdrawing I-V of PV

Idling voltage (U_{iv}) – voltage at which current is zero. On the other hand, the current at which the voltage is zero, is called short-circuit current ($I_{pv\ cells}$). This extreme points of I-V in which power PV is zero. Maximum values of voltage and current (I_{max} , U_{max}) at constant values of illumination and temperature determine the maximum power point (MPP). Figure 3 shows typical I-V and P-V curves of photovoltaic cells.

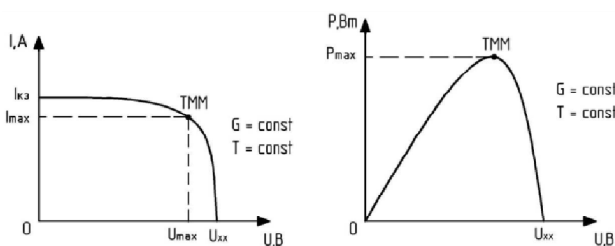

Fig. 3. Typical I-V and P-V curves of PV

Maximum power of PV – power of MPP on I-V characteristic where the value of the works of current maximum voltage [3].

Found that the intensity of the solar radiation affects the value of the output current and output voltage-temperature solar cell. So, if you reduce the intensity of the light flux in 2 times short-circuit current of PVcells decreases in 2 times, while idling

voltage changes slightly. There is the temperature coefficient, which takes into account the temperature differences and forming the order of a few milliamps to one degree Celsius.

Mathematical model of the photoelectric element is based on the classic equivalent lumped equivalent circuit (Fig. 4). This equivalent circuit generator includes photocurrent (I_{ph} was placed), shunt diode (R_{sh}) and serial (R_s) resistance [8].

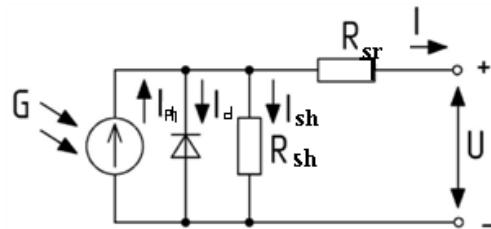

Fig. 4. Classic PVcell replacement equivalent circuit

In accordance with the equivalent substitution of PVcells, SE presented on Fig. 2, you can write

$$I = I_{ph} - I_d - I_{sh}, \tag{1}$$

where I is the load current; I_{ph} is the photocurrent; I_d is the current flowing through the diode; I_{sh} is the current flowing through the shunt resistance.

Expressing the magnitude of the currents through the physical parameters of PVcells get the analytical expression of I-V in the following form [8].

$$I - I_{ph} - I_u \left[\exp \left(\frac{q(U + IR_{sr})}{AkT} \right) - 1 \right] - \frac{U + IR_{sr}}{R_{sh}}, \tag{2}$$

where I_u is the reverse saturation current; U is the output voltage; R_{sh} is the shunt resistance of PVcells; R_{sr} is the serial resistance of PVcells; q is the charge of an electron; k is the Boltzmann constant; A is the I-V setting PV, called diode factor; T is the absolute temperature of the PVcells, K.

Due to the fact that the efficiency of the PVcells depends on the form of its I-V (Fig. 3), SE options included in equation I-V (2), determine the effectiveness of PVcells (2) represents the five parametric model I-V PV, representing special interest only to developers of solar cells and modules.

Efficiency of the photoelectric conversion is determined by light current-voltage characteristic of the PVcells the shape of which depends on a number of options: serial and parallel (shunt) resistances se saturation current density diode, diode coefficient and some other factor [6], [7].

Accordingly, the power generated by solar element equal $P = IU$.

Satisfactory accuracy of the model can be obtained, provided that internal resistance values are known for photovoltaic cells. Typically, when systematic deviations observed modeling theoretical curve I-V from experimental, resulting from variable density currents and voltage gradient [9].

Considered by the model is widely used in the analysis of solar cells, modules and panels, but the characteristics obtained from this model are minor, but sometimes unwanted deviations from the characteristics of the real solar cell or module. One of the reasons for the deviations is the difficulty of accurately measuring serial resistance element R_{sr} .

It should be noted that additional parameters included in (2), a significant influence on the shape of the I-V of PVcells has R_{sh} . Shunt resistance take big enough and series resistance is relatively small.

Simulation of characteristics of PV used in solving problems such as [9]:

- PVcells scheme optimization of PV;
- determination of optimal operating point in the changing light and temperature;
- evaluation of PVcell scheme losses;
- determination of the effect of partial shading on the output characteristics of PV and changes of its power;
- calculation and simulation of photovoltaic power supply systems;
- analysis and forecasting of the work of the photovoltaic plant.

When modeling I-V and P-V we need to know the basic settings of the solar module: short-circuit current ($I_{pv \text{ cells}}$) and the idling voltage (U_{iv}). These parameters are specified by the manufacturer in the Passport at a solar cell or module. From practice we

know that particular influence on the characteristics of PV have consistent resistance, temperature t and the diode option a . the smaller the amount, the more power, generated by PVcells, and therefore efficiency. With increasing temperature t decreases value of U_{iv} , and $I_{pv \text{ cells}}$ practically does not change its value [2].

Development of simulation model of solar module.

Construction of simulation model of solar photovoltaic module implemented in Matlab/Simulink environment. When designing this model, we used materials [10].

Developed by Simulink model, which allows to register the main characteristics of solar photovoltaic module is shown in Fig. 5.

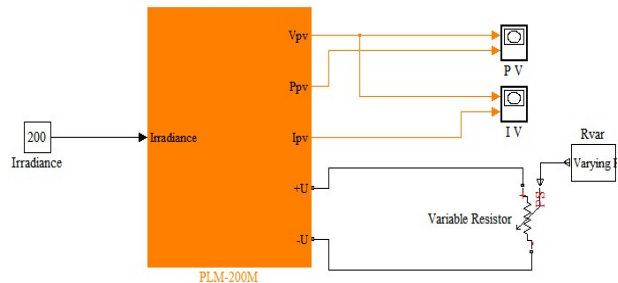

Fig. 5. Simulink characteristic measuring model of solar module

Constructed model includes the following subsystems and units.

"Irradiance" (Constant) sets the value of the intensity of solar radiation (G) W/m^2 . Specifies the block associated with the input port of the solar module subsystem.

The subsystem "PLM-200" is a solar module itself. Detailed structure of the proposed subsystem solar module is shown in Fig. 6.

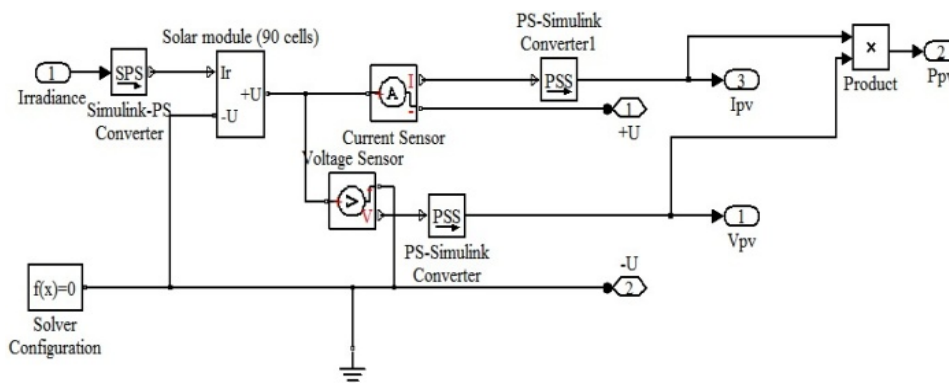

Fig. 6. Structure of subsystem of solar module

The subsystem contains the following blocks: "Simulink-PS Converter", "PS-Simulink Converter" – signal converter; "Voltage Sensor", "Current Sensor" current and voltage meters; "Solver Configura-

tion" is the configuration block; "Product" multiplication block.

Build in Simulink subsystem of the solar module, the output parameters which will match real multi-

crystalline Solar module PLM-200 (Perlight Solar) when light 1000 W/m^2 : $P = 200 \text{ W}$; $U = 37.8 \text{ V}$; $I = 5.3 \text{ A}$; $U_{iv} = 45.5 \text{ V}$; $I_{pv \text{ cells}} = 5.6 \text{ A}$.

From the library Simscape, select the existing universal block "Solar Cell". Configure the block is performed as an option, presented in Fig. 7. This

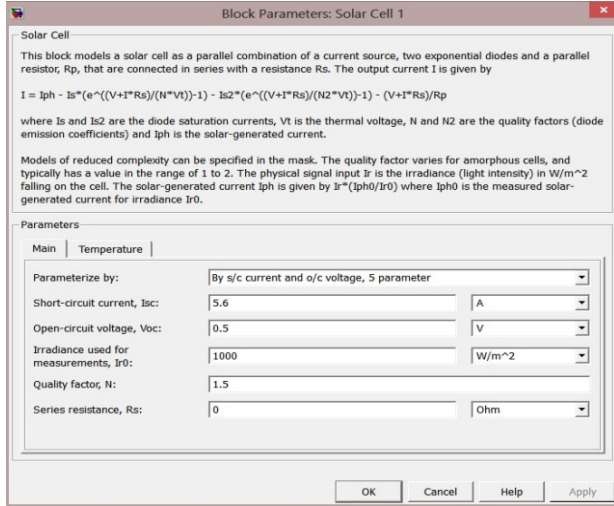

Fig. 7. Block settings Window "Solar Cell"

element describes the mathematical expression, shown in the upper part of the window settings. The value of the temperature settings are exposed in the next tab (Fig. 8).

Blocks of solar cells are connected consistently and combined into subsystems (Fig. 9).

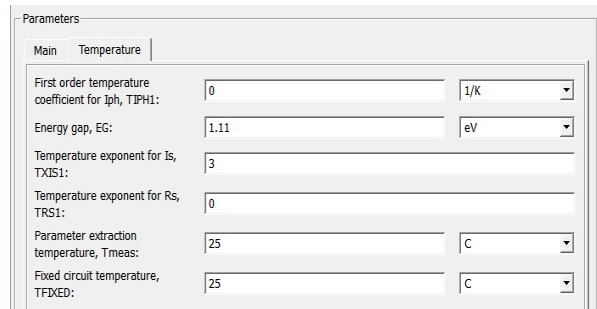

Fig. 8. Installing temperature values

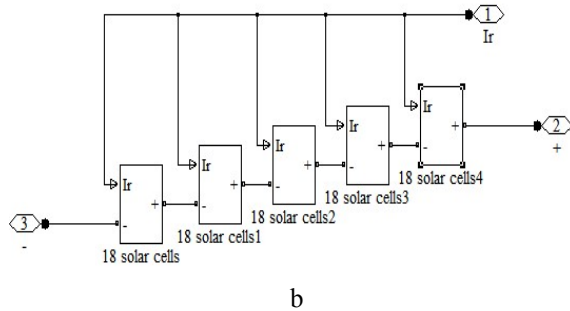
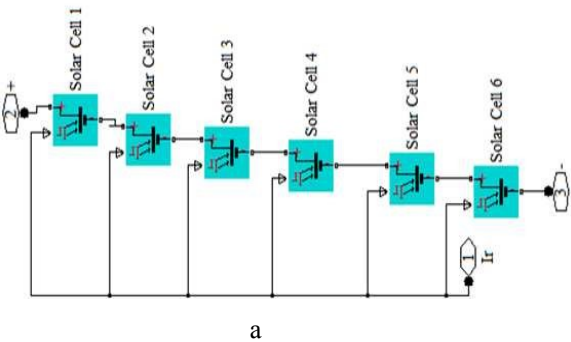

Fig. 9. Subsystem of "Solar Cell": (a) of 6 elements; (b) of 90 elements

The structure of the controlled resistance subsystem R_{var} includes block "Ramp", which generates a linear signal and convert block "Simulink-PS Converter".

The simulation results show blocks "PV", "IV" (XY graph builder), perform graphing values one signal in another function.

IV. THE SIMULATION RESULTS

The following assumptions were taken for modeling: I-V and P-V modeled without considering the partial shading of the perceived surface of PV and without possible damage. Assumption data provide a means of applying the classic analytical expressions for modeling the characteristics of PV.

Taking the temperature of the solar cells equal to 25° C (Fig. 8). It should also be noted that the accuracy of the simulation depends on the possible tech-

nological variations for each item and the module as a whole.

Simulation results are presented below (Fig. 10) with indicating the maximum power point values (MPP). Curves I-V and P-V obtained the following levels of illumination: 200; 400; 600; 800; $1000 \text{ (W/m}^2)$.

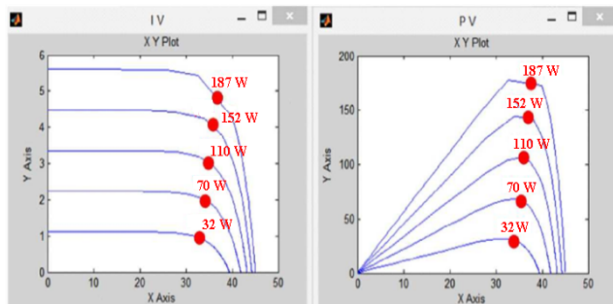

Fig. 10. I-V and P-V results of modeling

Figure 11 shows the family of current-voltage characteristics of monocrystalline solar module PLM-200 (Perlight Solar) at various levels of illumination (200; 400; 600; 800; 1000 (W/m²)) and a temperature of 25° C.

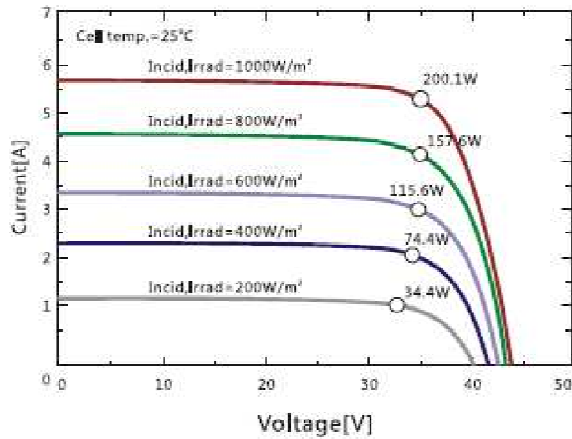

Fig. 11. Family wills-voltage characteristics monocrystal-line solar module PLM-200 (Perlight Solar)

Identify compliance characteristics of solar module manufacturer-provided and characteristics obtained by modeling in Matlab/Simulink. To do this, we shall make a comparison chart of the actual values in the module power maximum power points with values derived from simulations (Table I).

TABLE I
COMPARISON OF ACTUAL VALUES IN MPP
WITH SIMULATION RESULTS

No MPP	Technical Specifications, W	The simulation results, W	The variance between values, %
1	200.1	187	6.5
2	157.6	152	3.2
3	115.6	110	5
4	74.4	70	7
5	34.4	32	7

IV. CONCLUSIONS

Received a simulation model that allows you to display family I-V and P-V of solar modules depending on the level of intensity of solar radiation and temperature. The developed model describes the real solar module only with some degree of approxima-

tion, taking into account the assumptions. There are deviations obtained by simulation of current-voltage characteristics from the pilot. The main reason was the difficulty of accurately measuring deviations, coherent and shunt resistance of solar cells.

Matched the characteristics of solar module manufacturer-provided and characteristics obtained by modeling in Matlab/Simulink environment. The divergence of modeling results with Passport characteristics does not exceed 7%, that is acceptable and is accepted for engineering calculations. Thus confirms the adequacy of the proposed simulation model

REFERENCES

- [1] Renewables 2013. Global status report. Renewable Energy Policy Network for the 21st Century: www.ren21.net.
- [2] L. S. Lynin and A. S. Pashenko. "Modeling and researching the characteristics of photoelectric converters on the GaAs and GaSb base". *Technical physics journal*, no. 81, pp. 71–76, 2011. (in Russian)
- [3] GOST P 51594-2000, "Unconventional energy. Solar energy. Terms and Definitions." 2000.
- [4] M. M. Koltun. *Photoelement. BSE*. 3rd pub. Moscow, 1977, p. 607. (in Russian)
- [5] V. I. Ivanchura and A. V. Tchubar. "Energy models of elements of autonomous power systems." *SFU Journal. Technics and technology*. no. 2, pp. 179–190, 2012. (in Russian)
- [6] M. M. Koltun. *Optics and metrology of solar cells*. Moscow, Nauka, 280 p., 1985. (in Russian)
- [7] A. L. Fahrenbrugh and R. H. Bube. *Fundamentals of Solar Cells: Photovoltaic Solar Energy Conversion*. New York, 1983.
- [8] A. M. Vasylev and A. P. Landsman. *Semiconductor photoconverters*. Moscow, Sovetskoye Radio, 1976, 246 p. (in Russian).
- [9] A. B. Basilevskiy and M.V. Lukyuanenko. "Modeling of volt-ampere characteristics of solar cells." *Vestnik Sibirskogo gosudarstvennogo universiteta*. no. 4. pp. 63–66, 2005. (in Russian).
- [10] S. Said, A. Massoud, M. Benammar, and S. Ahmed. "A Matlab/Simulink-Based Photovoltaic Array Model Employing SimPowerSystems Toolbox." *Journal of Energy and Power Engineering*, no.6, pp. 1965–1975. 2012.

Received January 20, 2016

Sineglazov Viktor. Doctor of Engineering Science. Professor. Educational & Research Institute of Information and Diagnostic Systems, National Aviation University, Kyiv, Ukraine. Education: Kyiv Polytechnic Institute, Kyiv, Ukraine (1973). Research area: Air Navigation, Air Traffic Control, Identification of Complex Systems, Wind/Solar power plant. Publications: more than 600 papers. E-mail: svm@nau.edu.ua

Kopanев Vlad. Student.

Educational & Research Institute of Information and Diagnostic Systems, National Aviation University, Kyiv, Ukraine.

Research interests: Automatic control systems, Applied Mathematics, Wind/Solar power plant.

Publications: 5.

E-mail: tennobi@yandex.ru

В. М. Синеглазов, В. О. Копанев. Імітаційне моделювання сонячних установок з фотоелектричними перетворювачами в режимі відбору максимальної потужності в середовищі Matlab/Simulink

Розроблено математичну модель для дослідження роботи сонячної установки в середовищі Matlab/Simulink. Аналіз результатів дозволяє оцінити продуктивність сонячних установок.

Ключові слова: сонячна установка; фотоелектричний перетворювач; математична модель; вольт-амперні характеристики; імітаційне моделювання.

Синеглазов Віктор Михайлович. Доктор технічних наук. Професор.

Навчально-науковий Інститут інформаційно-діагностичних систем, Національний авіаційний університет, Київ, Україна.

Освіта: Київський політехнічний інститут, Київ, Україна (1973).

Напрямок наукової діяльності: аеронавігація, управління повітряним рухом, ідентифікація складних систем, вітроенергетичні установки.

Кількість публікацій: більше 600 наукових робіт.

E-mail: svm@nau.edu.ua

Копанев Владислав Олександрович. Студент.

Навчально-науковий Інститут інформаційно-діагностичних систем, Національний авіаційний університет, Київ, Україна.

Напрямок наукової діяльності: автоматичні системи управління, прикладна математика, вітроенергетичні установки.

Кількість публікацій: 5.

E-mail: tennobi@yandex.ru

В. М. Синеглазов, В. А. Копанев. Имитационное моделирование солнечных установок с фотоэлектрическими преобразователями в режиме отбора максимальной мощности в среде Matlab/Simulink

Разработана математическая модель для исследования работы солнечной установки в среде Matlab/Simulink. Анализ результатов позволяет оценить производительность солнечных установок.

Ключевые слова: солнечная установка; фотоэлектрический преобразователь; математическая модель; вольт-амперные характеристики; имитационное моделирование.

Синеглазов Виктор Михайлович. Доктор технических наук. Профессор.

Учебно-научный Институт информационно-диагностических систем, Национальный авиационный университет, Киев, Украина.

Образование: Киевский политехнический институт, Киев, Украина (1973).

Направление научной деятельности: аэронавигация, управление воздушным движением, идентификация сложных систем, ветроэнергетические установки.

Количество публикаций: более 600 научных работ.

E-mail: svm@nau.edu.ua

Копанев Владислав Александрович. Студент.

Учебно-научный Институт информационно-диагностических систем, Национальный авиационный университет, Киев, Украина.

Направление научной деятельности: автоматические системы управления, прикладная математика, ветроэнергетические установки.

Количество публикаций: 5.

E-mail: tennobi@yandex.ru