

МІНІСТЕРСТВО ОСВІТИ І НАУКИ УКРАЇНИ
НАЦІОНАЛЬНИЙ АВІАЦІЙНИЙ УНІВЕРСИТЕТ
ФАКУЛЬТЕТ АЕРОНАВІГАЦІЇ, ЕЛЕКТРОНІКИ ТА
ТЕЛЕКОМУНІКАЦІЙ
КАФЕДРА АЕРОНАВІГАЦІЙНИХ СИСТЕМ

ДОПУСТИТИ ДО ЗАХИСТУ

Завідувач кафедри

д-р техн. наук, проф.

_____ В.Ю. Ларін

«__» _____ 2020 р.

ДИПЛОМНА РОБОТА
(ПОЯСНЮВАЛЬНА ЗАПИСКА)
ВИПУСКНИКА ОСВІТНЬОГО СТУПЕНЯ МАГІСТРА
ЗА ОСВІТНЬО-ПРОФЕСІЙНОЮ ПРОГРАМОЮ
«ОБСЛУГОВУВАННЯ ПОВІТРЯННОГО РУХУ»

Тема: «GNSS характеристики та вплив погоди на фінальному етапі заходу на посадку»

Виконав:

К. Ірадукунда

Керівник: д-р техн. наук, проф.

Ю. Авер'янова

Нормоконтролер:

д-р техн. наук, проф.

Т. Шмельова

Київ 2020

**MINISTRY OF EDUCATION AND SCIENCE OF UKRAINE
NATIONAL AVIATION UNIVERSITY
FACULTY OF AIR NAVIGATION, ELECTRONICS AND
TELECOMMUNICATIONS
AIR NAVIGATION SYSTEMS DEPARTMENT**

PERMISSION FOR DEFENCE

**Head of the Department
Doctor of Sciences (Engineering), prof
_____ V.Yu. Larin
" _____ " _____ 2020**

**MASTER'S THESIS
ON THE EDUCATIONAL PROFESSIONAL PROGRAM
"SYSTEMS OF AIR NAVIGATION SERVICE"
(EXPLANATORY NOTE)**

**Theme: "GNSS Performance and Weather Interferences at the Final
Approach of an Aircraft: Towards an Algorithm for Safer Navigation"**

Performed by: _____ Clarisse Iradukunda

Supervisor: Doctor of Sciences, prof. _____ Yu. A. Averyanova

Advisers:

**Standard inspector:
Doctor of Science, prof. _____ T. Shmeleva**

KYIV 2020

НАЦІОНАЛЬНИЙ АВІАЦІЙНИЙ УНІВЕРСИТЕТ

Факультет аеронавігації, електроніки та телекомунікацій
Кафедра аеронавігаційних систем систем
Освітній ступінь «Магістр»
Спеціальність 272 «Авіаційний транспорт»
Освітньо-професійна програма «Обслуговування повітряного руху»

ЗАТВЕРДЖУЮ

Завідувач кафедри
д-р техн. наук, проф.

_____ В.Ю. Ларін
«___» _____ 2019 р.

ЗАВДАННЯ

на виконання дипломної роботи КЛАРИССА ІРАДУКУНДА

1. Тема роботи: «GNSS характеристики та вплив погоди на фінальному етапі заходу на посадку» затверджено наказом ректора от 29.10. 2019 года № 2524/ст.
2. Термін виконання проекту: 15.10.2019 - 30.01.2 020
3. Вихідні дані по роботі: Annex 10 to the Convention on International Civil Aviation, Aeronautical Telecommunications, Volume I Radio Navigation Aids”, ICAO, Sixth Edition, July 2006
 1. ICAO, International Standards and Recommended Practices, Annex 6 to Convention on International Civil aviation, Operation of aircraft, Eight edition, Jul. 2001
 2. ICAO, Performance-based Navigation (PBN) Manual, Third Edition, 2008
 3. ICAO, Common Taxonomy Team, CICTT, Phases of flight definitions and usage notes, Commercial Aviation Safety Team/ Feb. 2006
 4. ICAO DOC decision making , Jepperson 2001
4. Зміст пояснювальної записки: аналіз впливу аогодних факторів на сигнал GNSS; аналіз даних експерименту, розробка алгоритму; розробка рекомендацій щодо використання обладнання та прийняття рішення при заході на посадку.

5. Перелік обов'язкового графічного матеріалу: схема дослідження, результати експерименту, результати аналізу експерименту, алгоритм підтримки прийняття рішення.

6. Календарний план-графік

лен

Етапи дипломної роботи	Зміст сцени	Дата		Форма доповіді (номер дипломної роботи)
		Початок	Кінець	
1. Розробка додисертаційного дослідження під назвою « Продуктивність GNSS та перешкоди погоди під час остаточного підходу »	GPS сузір'я	14.10.19	17.10.19	Глава 4
	GPS + моделювання Galileo	18.10.19	20.10.19	Глава 4
	Вихідні результати багатоконстеляції GNSS	21.10.19	28.10.19	Глава 4
2. Розробка дипломної роботи: врахування інформації про погоду та впливу погоди на сигнали GNSS	Покоління тем	29.10.19	10.11.19	Глава 1
	Вступ до теми	11.11.19	18.11.19	Глава 1
	Огляд GNSS з прогнозом погодних перешкод	19.11.19	26.11.19	Глава 3
	Дослідження погоди	27.11.19	05.12.19	Глава 3
2. Процес збору даних в університетській лабораторії	Загальне вивчення цілісності супутників	06.12.19	14.12.19	Глава 3

супутникового моделювання	Різні сценарії моделювання	15.12.19	22.12.19	Глава 4
	Попередні результати моделювання	23.12.19	14.12.19	Глава 4
4. Підсумкове вивчення статті з презентацією та рекомендаціями	Представлення результатів роботи / попередній захист	20.01.2020	27.01.2020	Глава 4
	Інноваційний алгоритм вклад в дослідження	09.01.2020	09.02.2020	Глава 5

8. Дата видачі завдання: «14» жовтня_ 2019 р.

Керівник дипломної роботи _Ю. Авер'янова _____

Прийняв завдання до виконання К. Ірадукунда _____

NATIONAL AVIATION UNIVERSITY

Faculty: *Air Navigation, Electronics and Telecommunications*

Department: *Air Navigation Systems Department*

Educational degree: *Master*

The specialty: *272 "Aviation Transport"*

Educational Professional Program: *Air Traffic Service*

APPROVED BY

Head of the Department

V. Larin

“ ” 2020

Master's Thesis Assignment

Student's name: **Clarisse IRADUKUNDA**

1. The thesis theme: **“GNSS Performance and Weather Interferences at the Final Approach of an Aircraft: Towards an Algorithm for Safer Navigation”**

approved by the Rector's order of “02” November 2016 № 2555

2. The thesis should be performed from: 10.10.2019 to 30.01.2020

5. 3. Initial data: Annex 10 to the Convention on International Civil Aviation, Aeronautical Telecommunications, Volume I Radio Navigation Aids”, ICAO, Sixth Edition, July 2006

6. ICAO, International Standards and Recommended Practices, Annex 6 to Convention on International Civil aviation, Operation of aircraft, Eight edition, Jul. 2001

7. ICAO, Performance-based Navigation (PBN) Manual, Third Edition, 2008

8. ICAO, Common Taxonomy Team, CICTT, Phases of flight definitions and usage notes, Commercial Aviation Safety Team/ Feb. 2006

9. ICAO DOC decision making , Jepperson 2001

4. The content of the explanatory note (the list of problems to be considered): analysis of weather influence onto GNSS signals, experiment depiction, experimental data analysis, algorithm development, development of recommendations to choice of airborne equipment and decision making during the final approach”

5. The list of mandatory graphic materials: diagram of experiment, experimental data representation, results of experimental data analysis, developed algorithm.

6. Calendar Schedule of Performing the Master’s thesis.

Thesis stages	Stage content	Date		Form of report (number of thesis chapter)
		Beginning	End	
1. Development of pre-thesis research named “ESTIMATION OF GNSS INTEGRITY WITH DOUBLE CONSTELLATIONS GPS AND GALILEO”	GPS constellation	14.10.19	17.10.19	Chapter4
	GPS+ Galileo Simulation	18.10.19	20.10.19	Chapter 4
	Output results of the multi-constellation of GNSS	21.10.19	28.10.19	Chapter4
2. Thesis development: consideration of weather information and weather influence onto GNSS signals	Topic generation	29.10.19	10.11.19	Chapter 1
	Introduction of the topic	11.11.19	18.11.19	Chapter 1
	GNSS overview with weather interference outlook	19.11.19	26.11.19	Chapter 3
	Weather studies	27.11.19	05.12.19	Chapter 3
3.Data collections process in the University Laboratory of Satellite simulation	General study of Integrity of Satellites	06.12.19	14.12.19	Chapter 3
	Different simulation scenarios	15.12.19	22.12.19	Chapter 4,
	Pre-results of simulation	14.12.19	23.12.19	Chapter 4

4. Final study of the paper with presentation and recommendations	Presentation of the results of the work/pre-defence	20.01.2020	27.01.2020	Chapter 4
	Innovative Algorithm guidance contribution to the research	09.01.2020	09.02.2020	Chapter 5

8. Date of issue: «14» ЖОВТНЯ 2020 _____

Supervisor of master's thesis __ Yu. Averyanova _____

Excepted the task C. Iradukunda _____

ACKNOWLEDGEMENT

Thanks to Almighty God...

I am happy and glad to acknowledge my indebtedness and warmest thanks to everyone who contributed to the thesis. Firstly, to my supervisor, Dr Professor Yuliya Aryonova for her friendly guidance, dedication, expert advice which have been tremendous throughout all the stage of the work.

I would like to express my gratitude and thanks to Professor Pogurelskiy Oleksiy for an amazing and valuable discussion, great assistance during data collections and the improvement of the thesis.

I do thank especially Dr Ezechiel Sentama for the close attention by reading through the manuscript and take his time for comments and suggestions which play a high and a great contribute to the thesis.

Special thanks are due to my parents for their continuous support and understanding, without forgetting my siblings for their greatest and indirect contribution to this work with their constant encouragement.

My thanks are also extended to the faculty of Air Navigation System, all teachers accordingly for creating such platform of better learning throughout the research. Furthermore, my thanks go to this amazing people; Dmitry Yeremenko, Vitalii Lazorenko, Remy Kagoyera, Gisa Clinton Karangwa, Gladys Mwerinde, friends and all the unspoken names. I do value you all and I am indeed grateful.

This thesis has been written during my Masters' studies at Air Navigation department of National Aviation University, I would like to thank the entire University and mostly the foreign department for providing excellent working conditions, support and understanding.

ABSTRACT

In the Civil Aviation sphere, Research activities aim to improve efficiency and tightening safety targets by providing new strategies of operations, all this is achieved through the implementation of modern and new Communication, Navigation, Surveillance and Air Traffic Management process. In Air Navigation, these goals are met by improving the exiting services and introduce the new one applicable for navigation towards safety, more reliable approach in all weather conditions.

The Global Navigation Satellite System (GNSS) has been identified as a key to technology by providing essential position and timing information supporting flight and ATM operations. GNSS can be observed in the fitting of new CA Aircraft, since a majority of them are now equipped with its receivers.

GNSS contains numerous satellites, for instance GPS for The United State of America, Glonass for Russian Federation, Galileo for Europeans Unions, Beidou for Chinese, and more that are still under development. This Master's has demonstrated the power and benefits of combining two satellites for better performance This thesis argues that atmospheric layers (Ionosphere, Troposphere) do play a vital role on the perturbation of signals from Satellites, in order to improve navigation regardless of the lost signals. Pseudo-range model is presented together with the performance of GNSS integrity with two constellations (GPS combined with Galileo). However, a significant number of reports have been received on different harmful interference to GNSS signals and some suggestions to correct those were mentioned.

This thesis focuses on the final approach of an aircraft using combined signals for reliability and safety navigation in CAT I operation. Lastly an innovative algorithm is presented for better guidance at the final approach.

TABLE OF CONTENTS

Факультет аеронавігації, електроніки та телекомунікацій	iii
Кафедра аеронавігаційних систем систем.....	iii
Освітній ступінь «Магістр».....	iii
ACKNOWLEDGEMENT	ix
ABSTRACT	x
TABLE OF CONTENTS.....	xi
TABLE OF ACRONYMS.....	xv
LIST OF FIGURES.....	xxiii
LIST OF EQUATIONS.....	xxv
LIST OF TABLES	xxvi
LIST OF DIAGRAMS	xxvii
CHAPTER 1: Introduction	28
1.1 Background.....	28
1.1.1 Ground Based Augmentation System.....	29
1.2 Objectives	29
1.3 Thesis Organization.....	30
CHAPTER 2: Requirements Specification to The Master's Degree Thesis.....	32
2.1. Theme of master degree thesis	32
2.2. The background of master degree thesis	32
2.3. The goal and purpose of the work.....	32
2.3.1. The goal of the work.....	32

2.3.2. The purpose of the work.....	32
2.4. Input data sources.....	33
2.5. Estimated scientific results and order of their realization.....	33
2.5.1. Estimated scientific results	33
2.5.2. Order of scientific results realization.....	33
2.6. Order of scientific results realization.....	33
2.7 Stages of work	34
CHAPTER 3: Navigation Performance, Requirements for Civil Aviation and GNSS...	36
Processing	36
PART I.....	36
3.1 Civil Aviation Authorities	36
3.1.1 International Civil Aviation Organization (ICAO).....	36
3.1.2 FAA and EASA	37
3.2 The Civil Aviation GNSS Concept	37
3.3 Phases of Flight.....	38
3.3.1 Categories of flight phases	38
3.3.2 Approaches.....	38
3.4 Performance Based Navigation PBN.....	44
3.5 Navigation Performance Criteria.....	47
3.5.1 Accuracy	47
3.5.2 Availability.....	47
3.5.3 Continuity.....	47
3.5.4 Integrity.....	48
3.6 SIS Performance Requirements.....	49
PART II	50
3.7 GNSS Constellations, GNSS Signals measurement model and Augmentation Systems	50

3.7.1 GNSS Constellations	50
3.7.2 GNSS Signals	55
3.7.3 GNSS Pseudo-Range Measurement Model	57
3.7.4 GNSS Augmentation Systems	58
3.7.6 Integrity Navigation System Performance	60
3.7.6 Integrity Monitoring	61
3.7.7 Protection Level (PL)	65
3.8 Weather Classifications and the impact on GNSS signals	67
3.8.1 Troposphere	68
3.8.2 Ionosphere	70
3.8.3 Atmospheric Error Correction	72
PART III. General Process of GNSS Simulation	73
3.9 Simulation Equipment's	73
3.9.1. Personal Computer (PC)	73
3.9.1 GNSS antennas	74
3.9.2 The GNSS Signal Splitter	76
3.9.3 GNSS Receiver	78
3.9.4 Component Software	80
3.9.4 Model visualization	82
3.9.5 Scheme diagram of Simulation Process	86
CHAPTER 4: Results and Analysis	87
4.1 GPS simulation	87
4.1.1 VP and HP Analysis	89
4.2 GPS and Galileo simulation	93
4.3 Innovative Algorithm	97
CHAPTER 5: Conclusion and Recommendation	98

Table of Contents

5.1 Conclusion.....	98
5.2 Recommendations.....	99
REFERENCES.....	100
APPENDICES.....	105
Appendix A.....	105
Pseudo-range Generation.....	105
Multi-GNSS constellation.....	108
Appendix B.....	110
General view of software output.....	110
General description of RAIMSTATUS and BESTPOS.....	114
Appendix C.....	120
Stanford Plots.....	120
Appendix D.....	127
Troposphere and Ionosphere Algorithm.....	127
GNSS Ionospheric Algorithm.....	127
GNSS Tropospheric Algorithm.....	128
Appendix E.....	129
Final Approach of Aircraft.....	129
The Rule of Thumb.....	131

TABLE OF ACRONYMS

A/C	Aircraft
AAD	Aircraft AD
AAIM	Aircraft Autonomous Integrity Monitoring
ABAS	Aircraft Based Augmentation System
AD	Accuracy Designator
ADB	Additional Data Block
APD	Approach Performance Designator
APV	Approaches with vertical guidance
ARAIM	Advanced Receiver Autonomous Integrity Monitoring
ARNS	Aeronautical Radio Navigation Services
AST	Active Service Type
ATM	Air Traffic Management
BAM	Bias Approach Monitor
BEIDU	Chinese satellite navigation system
BMCS	Back-up Master Control Station
C/A	Coarse/Acquisition
CA	Civil Aviation
CAT-I	Category 1
CAT-II	Category 2

Table of Acronyms

CCD	Code Carrier Divergence
CMC	Code Minus Carrier
CNS	Communication Navigation and Surveillance
D	Distance
DA	Decision Altitude
DCMC	Differential Correction Magnitude Check
DC	Direct Current
DCP	Data Collection Platforms
D-free	Divergence Free
DME	Distance Measuring Equipment
DGNSS	Differential GNSS
DGPS	Differential GPS
DOP	Dilution of Precision
DH	Decision Height
DQM	Data Quality Monitoring
DSIGMA	Dual Solution Iono Gradient Monitoring Algorithm
EASA	European Union Aviation Safety Agency
EGNOS	European Geostationary Navigation Overlay Service
EPE	Estimated Position Error
ESA	European Space Agency
EUROCAE	European Organization for Civil Aviation Equipment
EUROCONTROL	European Organization for the Safety of Air Navigation
F	Frequency
FAA	Federal Aviation Administration
FAF	Final Approach Fix

Table of Acronyms

FANS	Future Air Navigation Systems
FAS	Final Approach Segment
FAST	Facility Approach Service Type
FASVAL	FAS Vertical Alert Limit
FD/FDE	Fault Detection/Exclusion
Ft	Feet
FTE	Flight Technical Error
GAD	Ground AD
GAST	GBAS Approach Service Type
GBAS	Ground Based Augmentation System
GCID	GBAS Continuity/Integrity Designator
GDOP	Geometric Dilution Of Precision
GEO	Geostationary
GFC	GBAS Facility Classification
GGTO GPS/GALILEO	GPS to Galileo Time offset
GIC	Ground Integrity Channel
GLONNAS	Global Navigation Satellite System
GLS	GBAS Landing System
GND	Ground
GNSS	Global Navigation Satellite System
GPIP	Glide Path Intersection Point
GPS	Global Positioning Service
GPS L1 C/A	signal uses the frequency 1575.42 MHz
GPS L1C	Fourth civilian GPS signal; the radio frequency used by the signal (1575 MHz, or L1)

Table of Acronyms

GPS L2C	Second civilian GPS signal; the radio frequency used by the signal (1227 MHz, or L2)
GPS L5	Third civilian GPS signal; the radio frequency used by the signal (1176 MHz)
GS	Group Separation
H	Height
HAL	Horizontal Alert Limit
HAT	Height Above Threshold
HMI	Hazardous Misleading Information
HPDCM	Horizontal Position Differential Correction Magnitude
HP	Horizontal Performance
HPE	Horizontal Position Error
HPL	Horizontal Protection Level
IAF	Initial Approach Fix
ICAO	International Civil Aviation Organization
IF	Intermediate Fix
IFR	Instrument Flight Rules
I-free/IF	Ionosphere Free
IGM	Iono Gradient Monitor
ILS	Instrument Landing System
INS	Inertial Navigation System
IRNSS	Indian Regional Navigation Satellite System
LAAS	Local Area Augmentation System
LAL	Lateral Alert Limit
LDT	Low Data Transmission
LOC	Localizer

Table of Acronyms

LOS	Line of Sight
LPL	Lateral Protection Level
LSE	Least Square Estimation
LTP/FTP	Landing/Fictitious Threshold Point
LUT	Look up Table Transmission
LoA	Letter of Acceptance
MAPt	Missed Approach Point
MC	Multi-Constellation
MCS	Master Control Station
MDA	Minimum descent Altitude
MDH	Minimum Decision height
MDM	Measurement Quality Monitoring
MEO	Medium Earth Orbit
MF	Multi-Frequency
MHM	Modified Hopfield Model
MHSS	Multiple Hypothesis Solution Separation
MI	Misleading Information
Min	Minutes
MMR	Multi-Mode Receiver
MOPS	Minimum Operational Performance Standards
MRCC	Multiple Receiver Consistency Check
MT	Message Type
Nm	Nautical mile
NavAids	Navigation Aids
NPA	Non Precision Approach

Table of Acronyms

NSE	Navigation System Error
NWM	Numerical Weather Model
OWAS	Optimally Weighted Average Solution
P	Pressure
PA	Precision Approach
PAN	Position and Navigation
PBN	Performance Based Navigation
PDE	Path Definition Error
PEE	Position Estimation Error
PL	Protection Level
PNT	Positioning, Navigation and Timing
PPP	Precise Point Positioning
PRC	Pseudo-range Correction
PRN	Pseudo-Random Noise
PSE	Path Steering Error
PVT	Position Velocity Time
QZSS	Quasi-Zenith Satellite System
RAIM	Receiver Autonomous integrity Monitoring
RF	Radio Frequency
RH	Relative Humidity
RNAV	Area Navigation
RNP	Required Navigation Performance
RNSS	Radio Navigation Satellite Services
PRM	Rotation per Minute
RR	Reference Receiver

Table of Acronyms

RRC	Range Rate Correction
RRFM	Reference Receiver Fault Monitor
RTCA	Radio Technical Commission for Aeronautics
RVR	Runway Visual Range
SAIM	Satellite Autonomous Integrity Monitoring
SARPs	Standards and Recommended Practices
SatNav	Satellite Navigation
SBAS	Satellite Based Augmentation System
SC	Single Constellation
SESAR	Single European Sky ATM Research
SF	Single Frequency
SHD	Slant Hydrostatic Delay
SIS	Signal In Space
SQM	Signal Quality Monitoring
SSR	Secondary Surveillance Radar
SST	Selected Service Type
STD	Slant Tropospheric Delay
SWD	Slant Wet Delay
T	Time
T-37	Cessna T-37
TC	Tropospheric Correction
TEC	Total Electron Content
TOW	Time of a Week
TSE	Total System Error
TTA	Time to Alert

Table of Acronyms

UERE	User Equivalent Residual Error
U.S.	United States
V	Velocity
VAL	Vertical Alert Limit
VDB	VHF Data Broadcast
VFR	Visual Flight Rules
VHF	Very High Frequency
VP	Vertical Performance
VPL	Vertical Protection Level
VPE	Vertical Position Error
VVI	Vertical Velocity Indicator
WAAS	Wide Area Augmentation System
WADGNSS	Wide Area DGNSS
WGS-84	World Geodetic System
WP	Work Package
WSS	Worst Satellite Subset
ZTD	Zenith Tropo Delay

LIST OF FIGURES

Figure 1. Phases of flight and GNSS augmentations [11]	39
Figure 2. RNAV (GNSS) Instrument Approach chart, for illustration purposes only – not to be used for navigation	43
Figure 3. Total System Error [15]	46
Figure 4. GPS.....	53
Figure 5. GPS and Galileo frequency bands [22]	57
Figure 6. Relationship between alert and protection levels: a) available integrity monitoring system, b) unavailable integrity monitoring system [26]	66
Figure 7. Atmospheric layers [36].....	68
Figure 8. Tropospheric effects [37]	69
Figure 9. PC used in GNSS Simulation	74
Figure 10. GNSS Antenna	76
Figure 11. GNSS splitter.....	77
Figure 12. Novatel ProPak LB plus.....	79
Figure 13. Receiver Novatel ProPak G2	80
Figure 14. MATLAB (more in Appendix B)	82
Figure 15. Possible situations obtained with GNSS integrity monitoring [53]	85
Figure 16. Plot of HPE/HPL	91
Figure 17. Plot of VPE/VPL	92
Figure 18. HPE/HPL of GPS + Galileo	95
Figure 19. VPE/VPL of GPS + Galileo	96
Figure 20. Demonstration of GNSS measuring time from transmitter to receiver	107
Figure 21. Pseudo-range generation	108
Figure 22. Stanford combined plots.....	114
Figure 23. Standard Deviation	120
Figure 24. Standard deviation of HPE	121
Figure 25. Distortion of errors.....	121

List of Figures

Figure 26. Second Standard deviation of HPE	122
Figure 27. Protection Level cylinder	122
Figure 28. VAL and LAL demonstration.....	124
Figure 29. Standard deviation of HPE	124
Figure 30. Standard deviation	125
Figure 31. Second Standard deviation of HPE	125
Figure 32. Second Standard deviation of VPE	126
Figure 33. Distortion of errors.....	126
Figure 34. Ionosphere and Troposphere demonstration	128
Figure 35. Cockpit view	129
Figure 36. Glide path.....	130

LIST OF EQUATIONS

Equation 1. GDOP measure accuracy in 3D position and time	56
Equation 2. Covariance matrix of the position and time correction errors	56
Equation 3. Pseudo-range model.....	57
Equation 4. Geometric Range	58
Equation 5. Corrected Pseudo-range measurement model	58
Equation 6. The probability of loss of integrity at time epoch t_i	60
Equation 7. The probability of HMI at time epoch t_i	61
Equation 8. Residual vector	63
Equation 9. Residue vector with matrix	63
Equation 10 (Matrix). Satellite navigation system matrix	64
Equation 11. Expression matrix	64
Equation 12. Estimated correction vector	64
Equation 13 (Matrix). Weight matrix of measurement	64
Equation 14. Residual vector with idempotent matrix	65
Equation 15. Least square based RAIM test.....	65
Equation 16. Estimated Position.....	66
Equation 17. Signal delay rate due to troposphere.....	69
Equation 18. Ionospheric delay	71
Equation 19. TEC Equation	72
Equation 20. Pseudo-range measurement	105
Equation 21. GNSS system time measurement	106
Equation 22. Measurement time.....	107
Equation 23. Extended navigation.....	109
Equation 24. GDOP distribution of satellites	109
Equation 25. GNSS Ionosphere Algorithm	127
Equation 26. GNSS Tropospheric Algorithm.....	128
Equation 27. Final approach Speed	130
Equation 28. Vertical Velocity Indicator	130

LIST OF TABLES

Table 1. Stages of work	34
Table 2. Decision heights and Visual requirements [12].....	40
Table 3. SIS performance requirements [3]	49
Table 4. GPS Signals for Civil Aviation.....	52
Table 5. GALILEO Signals for Civil Aviation.....	54
Table 6. Numerical Analysis of VP and HP.....	90
Table 7. RAIMSTATUS description	115
Table 8. BESTPOS description	117
Table 9. Integrity monitoring	119
Table 10. Navigation Performance	123

LIST OF DIAGRAMS

Diagram 1. Splitter [45].....	77
Diagram 2. Stanford Diagram [49].....	84
Diagram 3. GNSS simulation Process	86
Diagram 4. Stanford Plot for the Vertical Performance	88
Diagram 5. Stanford Plot for the Horizontal Performance	89
Diagram 6. Vertical Performance of GPS + Galileo	93
Diagram 7. Horizontal Performance of GPS + Galileo	94
Diagram 8. Developed innovative Algorithm	97

CHAPTER 1

Introduction

1.1 Background

Nowadays, most of the civil aviation aircrafts are equipped with Global Navigation Satellite System (GNSS) receivers (90% of aircrafts according to the EUROCONTROL Survey [1]) and since, it was recognized as a key technology in providing accurate navigation services with a worldwide coverage. This GNSS concept was defined by the International Civil Aviation Organization (ICAO). In this days, aviation industry uses this safety navigation for various duties at the Airport, However, GNSS signals has been facing some failure in different phases of a flight and most of those failure were the results of atmospheric weather. This work will look on the weather impact on the GNSS signals, considering that the signals travel from a data collection platforms (DCP) to a satellite crossing the terrestrial atmosphere, they are affected by the atmosphere layers, which generate a delay in the signal propagation, and cause errors in its final location coordinates computation.

The signal propagation delay due to the atmospheric effects which essentially consists of the ionospheric and tropospheric effects [2]. This work shows the impact of tropospheric and ionospheric signal delay and the benefit of using multi-constellations satellite in case of signal failure propagation on the final approach of an Aircraft as well as approved augmentations. In view of the stringent civil aviation specifications and requirements defined for the use of GNSS within the CNS/ATM system (Communications, Navigation, and Surveillance / Air Traffic Management), a stand-alone core constellation need augmentations systems for meeting requirements specified by ICAO [3] in terms of accuracy, integrity, availability and continuity.

GNSS is currently used in civil aviation from en-route to precision approaches (CAT I) mostly with Global Positioning System (GPS) constellation, this work is interesting to assess the

feasibility of extending the use of GNSS with multi constellation satellites to Precision Approach (PA) for reliable and safety navigation at the final approach of Airborne.

1.1.1 Ground Based Augmentation System

As mentioned above, in view of the stringent civil aviation requirements specified by ICAO [3], augmentation systems were developed for improving performances beyond core constellations performance. In particular, for precision approaches, GBAS (Ground Based Augmentation System) was defined and use the Differential GNSS (DGNSS) technique that significantly improves both the accuracy and the integrity within a local coverage area around the airport. This system is intended to provide an alternative to the already implemented Instrument Landing System (ILS) which suffers from a number of limitations and siting constraints. Then, the term GBAS Landing System (GLS) [4] was assigned to the approach procedure/capability provided by such a system (precision approaches and landing operations).

Today, GBAS installations are standardized to provide precision approaches down to Category I (CAT-I) and are based on GPS and GLONASS using a single frequency (GPS L1 C/A). GBAS CAT II/III service with a single protected signal (GPS L1 C/A) is at an advanced stage of development and standardization. It is expected that the evolution of GBAS towards multi-constellation (MC) and multi-frequency (MF) provide better performance and robustness as well as the availability of services. In this Masters project the multi-constellation focus is on GPS/GALILEO.

1.2 Objectives

The overall objective of this Master's thesis is to analyze the interferences of Atmospheric Weather on the integrity of GNSS signals navigation systems and develop an innovative algorithm for safer navigation taken from the results of GPS and Galileo constellation with special attention to Precision Approach (CAT I). Specifically, the study focuses on the following objectives:

- To Review the causes and the effects of Atmospheric weather to GNSS Signals;
- To Analyze the Integrity Monitoring model in the less number of visible Satellites;

- To Develop an innovative algorithm for a safe navigation at the final approach of an Aircraft.

1.3 Thesis Organization

This sub-section presents the general organization of this thesis.

Chapter 1 start with the introduction and general background of GNSS and its impact on the Civil aviation navigation, it continues with a brief view of the available systems and present the objectives of the thesis and its contribution to safer navigation at the final approach and lastly highly the thesis organization

Chapter 2: Introduces the Requirement specifications to the Master's degree Thesis

Chapter 3: Highlights the Navigation Performance Requirements for Civil aviation, GNSS Processing. Therefore, this chapter contains the division of two Parts;

Part I, First, deals with all the requirement of Civil Aviation Authorities; second, it presents the view of International Civil Aviation Organization (ICAO) so as Federal Administration Authority (FAA) and European Union Aviation Safety Agency (EASA) with a brief view of Civil Aviation GNSS concept. Third, The following part describes the different phases of flight with an emphasis on approaches. The concept of Performance Based Navigation (PBN) is presented, followed by a section dealing with the navigation performance criteria of ICAO for GNSS based navigation. Finally, the corresponding Signal In Space (SIS) requirements are reminded for each phase of the flight.

Part II, First, emphasizing on the GNSS Processing considered in this Masters Work. First GNSS multi constellation is presented with an introduction of satellite signals, Geometric dilution of precision (GDOP) and mask angle. Second, the different steps for establishing the position estimation and the navigation solution are described by explaining how the pseudo-range measurement is obtained and corrected for being used to estimate the position. The GNSS augmentation system was described, Furthermore, some methodologies enabling to measure the trust on the correctness of this position and system performances are presented by detailing integrity monitoring concepts for GNSS systems. Protection level of all sorts, VPL and HPL were mentioned. Third, weather classification and impact on GNSS signals were discussed

taking into account the critical atmospheric layers, Troposphere and Ionosphere, thus the correction of the Troposphere and Ionosphere meteorological modelling were computed.

Part III, Highlight the general process of GNSS simulation performed in this Thesis, starting with the equipment used to process the received data from the satellites, describing the used antenna, it's power and how the signals are splitter. continues with kinds of receivers used in this study and the component of software that were available on data process, mentioning the visualization mode of the received information by the use of Stanford diagram, lastly the scope of simulation process was presented in scheme accordingly.

Chapter 4: Analyses the results of two possible treats and the available probability for Vertical and Horizontal levels simulated on different days and different mask Angles, the influence of Atmospheric layers on the visible number of Satellites, thereafter develop an innovative Algorithm for a safe navigation at the final approach.

Chapter 5: Present the conclusions of this Master's Work and recommendations for future work.

CHAPTER 2

Requirements Specification to The Master's Degree Thesis

2.1. Theme of master degree thesis

GNSS performance and weather interferences at the final approach of an aircraft.

2.2. The background of master degree thesis

- The curriculum of educational qualification of "Master" on specialty 272 "Aviation Transport" of Educational and Professional Program "Air Traffic Service" № CM-14-272/16.

- The Rector's order of topics and heads of diploma approval № 2524/ср. from 29.10.2019.

2.3. The goal and purpose of the work

2.3.1. The goal of the work

The goal of the work is to improve the pilot's awareness about GNSS signal availability at the final approach of flight.

2.3.2. The purpose of the work

To review the causes and the effects of Atmospheric weather to GNSS Signals; to analyze the Integrity monitoring model in least number of visible satellites; to develop an innovative algorithm for a safe navigation at the final approach of aircraft.

2.4. Input data sources

10. "Annex 10 to the Convention on International Civil Aviation, Aeronautical Telecommunications, Volume I Radio Navigation Aids", ICAO, Sixth Edition, July 2006
11. ICAO, International Standards and Recommended Practices, Annex 6 to Convention on International Civil aviation, Operation of aircraft, Eight edition, Jul. 2001
12. ICAO, Performance-based Navigation (PBN) Manual, Third Edition, 2008
13. ICAO, Common Taxonomy Team, CICTT, Phases of flight definitions and usage notes, Commercial Aviation Safety Team/ Feb. 2006
14. ICAO DOC decision making , Jepperson 2001

2.5. Estimated scientific results and order of their realization

2.5.1. Estimated scientific results

As the result of scientific research the following scientific results should be obtained:

- Algorithm for estimation and prediction availability of GNSS data for a safe navigation of aircraft at the final approach.

2.5.2. Order of scientific results realization

Obtained scientific results should be available for the application in the process of

- Selection of optimal procedure for performing flight tasks.
- Formation of recommendations for pilots and ATC operators to improve the quality of navigation support at the final approach.

2.6. Order of scientific results realization

Degree Thesis must be performed in accordance with the methodical guidelines and requirements of master's thesis work performance for students of educational direction 6.070102 "Aeronavigation" direction and State Standard of Ukraine 3973-2000 "СРППВ. Правила виконання науково-дослідних робіт. Загальні положення (SRPPV. Terms of scientific research performance. Basics.)". The work must be properly and correctly prepared in the compliance with requirements of scientific work.

The explanatory note is issued in accordance with State Standard of Ukraine 3008-95 "Документація. Звіти у сфері науки і техніки (Documentation. Reports in science and technology.)"

2.7 Stages of work

Table 1. Stages of work

Thesis stages	Stage content	Date		Form of report (number of thesis chapter)
		Beginning	End	
1. Development of pre-thesis research named "ESTIMATION OF GNSS INTEGRITY WITH DOUBLE CONSTELLATIONS GPS AND GALILEO"	GPS constellation	14.10.19	17.10.19	Chapter4
	GPS+ Galileo Simulation	18.10.19	20.10.19	Chapter 4
	Output results of the multi-constellation of GNSS	21.10.19	28.10.19	Chapter4
2. Thesis development: consideration of weather information and weather influence onto GNSS signals	Topic generation	29.10.19	10.11.19	Chapter 1
	Introduction of the topic	11.11.19	18.11.19	Chapter 1
	GNSS overview with weather interference outlook	19.11.19	26.11.19	Chapter 3
	Weather studies	27.11.19	05.12.19	Chapter 3

CHAPTER 2: Requirements Specification to The Master's Degree

3.Data collections process in the University Laboratory of Satellite simulation	General study of Integrity of Satellites	06.12.19	14.12.19	Chapter 3
	Different simulation scenarios	15.12.19	22.12.19	Chapter 4,
	Pre-results of simulation	23.12.19	14.12.19	Chapter 4
4. Final study of the paper with presentation and recommendations	Presentation of the results of the work/pre-defense	20.01.2020	27.01.2020	Chapter 4
	Innovative Algorithm guidance contribution to the research	09.01.2020	09.02.2020	Chapter 5

CHAPTER 3

Navigation Performance, Requirements for Civil Aviation and GNSS

Processing

This part of the thesis summarizes the requirements applicable to GNSS use for civil air navigation and integrity monitoring. In order to understand clearly each function, Civil Aviation Authorities such as ICAO, EUROCAE, FAA and EASA are first introduced. Then, in order to clarify where and when requirements are applicable, the different categories of phases of flight are presented according to approaches. After, the concept of Performance Based Navigation (PBN) is described. Finally, the navigation performance criteria of ICAO for GNSS based navigation are defined through the associated Signal In Space requirements reminded for each phase of flight.

PART I

3.1 Civil Aviation Authorities

3.1.1 International Civil Aviation Organization (ICAO)

The International Civil Aviation Organization (ICAO) is the agency of the United Nations, which elaborates all concepts and techniques for international air navigation and organizes the planning and development of international air transport to provide safe and regulated growth. Its council ratifies standards and recommended practices (SARPs) concerning air navigation, prevention of unlawful interference, and facilitation of border-crossing procedures for international civil aviation. Moreover, the ICAO defines the formalities for air accident investigation followed by authorities in countries that had signed the Convention on International Civil Aviation, commonly known as the Chicago Convention.

Furthermore, the main role of the International Civil Aviation Organization (ICAO) is to establish the standards for radio navigation aids, including those concerning Global Navigation Satellite Systems (GNSS). They are defined in Annex 10 to the Convention on International Civil Aviation. [5]

3.1.2 FAA and EASA

FAA and EASA form the authorities which are officially responsible for publishing compulsory requirements to be respected by aircraft manufacturers and airlines to fly an aircraft.

The FAA is an agency of the United States Department of Transportation and the EASA is similar to the European Commission. Their aim is to enable safe civil aviation air traffic. Most of their published documents refer to the standardization publications established by the previous organizations. It is relevant to mention here publications that are directly related to this Master's work and which are the airworthiness criteria for landing operations. These can be found in FAA Advisory Circular AC 120-28D and EASA CS AWO [6].

3.2 The Civil Aviation GNSS Concept

The Global Navigation Satellite System (GNSS) concept was introduced and developed by ICAO (International Civil Aviation Organization) and more precisely by the FANS (Future Air Navigation Systems) committee. It is included in the CNS/ATM concept (Communication Navigation Surveillance/Air Traffic Management) established by ICAO in 1983 and adopted in 1991. The operational plan of this latter was adopted by ICAO in 2003 and remains set around the world [7]. GNSS is defined by ICAO as a system capable of estimating position and time and composed of one or several satellite constellations, aircrafts embedded receivers and an integrity monitoring function. GNSS was inspired by GPS and GLONASS systems but whilst similar in principle, the ICAO requirements are so stringent in terms of accuracy, integrity, availability, and continuity that GPS standalone receivers cannot be used without augmentation by an integrity monitoring solution.

After having presented the different organizations which have a role in the elaboration of the standards related to the use of GNSS systems for civil aviation, (referring to 3.1.2) the standardized phases of flight for civil aircraft flights are presented in the following section.

3.3 Phases of Flight

3.3.1 Categories of flight phases

The flight of an aircraft consists of six major phases [8]:

- **Take-Off:** From the application of take-off power, through rotation and to an altitude of 35 feet above runway elevation or until gear-up selection, whichever comes first.
- **Departure:** From the end of the take-off sub-phase to the first prescribed power reduction, or until reaching 1000 feet above runway elevation or the VFR pattern (Visual Flight Rules), whichever comes first.
- **Cruise:** Any level flight segment after arrival at the initial cruise altitude until the start of the descent to the destination.
- **Descent:**
 - Instrument Flight Rules (IFR): Descent from cruise to either Initial Approach Fix (IAF) or VFR pattern entry.
 - Visual Flight Rules (VFR): Descent from cruise to the VFR pattern entry or 1000 feet above the runway elevation, whichever comes first.
- **Final Approach:** From the FAF (Final Approach Fix) to the beginning of the landing flare.
- **Landing:** Transition from nose-low to nose-up attitude just before landing until touchdown.

As this thesis focus on Approaches operations, the detailed description is given in the following section.

3.3.2 Approaches

Categories of aircraft approaches are defined through the level of confidence that can be placed by the pilot into the system he used in order to land the plane safely. They are divided into two main segments: the first one is the aircraft segment which follows the indication provided by the landing system, and the second is the pilot segment which takes over in the final part and controls the aircraft using visual outside information.

As the reliability of the aircraft, the crew and the landing system increases, the height of the aircraft over the ground at the end of the interval of use of the information provided by the system can be decreased [9].

Three classes of approaches and landing operation have been defined by the ICAO in Annex 6 [10] and are classified as follows:

- **Non Precision Approaches and landing operations (NPA):** They are defined by an instrument approach and landing which uses lateral guidance but does not use vertical guidance.
- **Approaches and landing operations with vertical guidance (APV):** They are defined by an instrument approach and landing which uses lateral and vertical guidance but does not meet the requirements established for precision approach and landing operation.
- **Precision approaches and landing operations (PA):** They are defined by an instrument approach and landing which uses precision lateral and vertical guidance with minima defined by the category of operation.

The different phases of flight and type of approaches are represented on Figure 1 with the type of GNSS augmentations that enable navigation operations for civil aviation during the corresponding phase of flight.

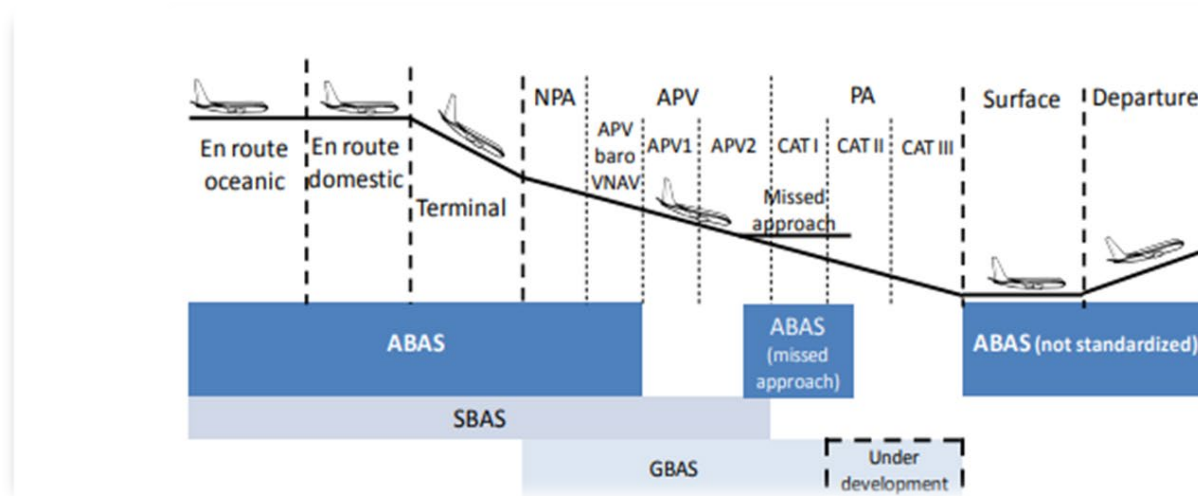

Figure 1. Phases of flight and GNSS augmentations [11]

The approaches can be defined using three different operational parameters which are the Decision Height (DH), the Distance of Visibility and the Runway Visual Range (RVR). These Parameters are defined below;

Decision Height (DH) is the minimum height above the runway threshold at which as missed approach procedure must be executed if the minimal visual reference required in order continuing the approach has not been established.

Distance of Visibility is the greatest distance, determined by atmospheric conditions and expressed in units of length, at which it is possible with the unaided eye to see and identify, in daylight a prominent dark object, and at the night a remarkable light source.

Runway Visual Range (RVR) is the maximum distance in the landing direction at which the pilot on the centerline can see the runway surface markings, runway lights, as measured at different points along the runway and in particular in the touchdown area.

The links between these parameters and the approach categories are represented in the following table defined by the ICAO.

Table 2. Decision heights and Visual requirements [12]

<i>Operations</i>	<i>Minimum Descent Altitude (MDA) Minimum Descent height (MDH) Decision Altitude (DA) Decision Height (DH)</i>	<i>Visual Requirements</i>
<i>NPA</i>	<i>MDA ≥ 350ft DH > 107m</i>	<i>Depending on the Airport equipment</i>
<i>APV</i>	<i>DA ≥ 250ft DH > 76m</i>	
<i>LPV</i>	<i>DH > 60m(200ft)</i>	
<i>Precision Approach CAT-I</i>	<i>DH ≥ 60m(200ft)</i>	<i>Visibility ≥ 800m or RVR ≥ 550m</i>

3.3.2.1 Approach Procedures

RNAV (GNSS) approaches must be in accordance only with published approach procedures that are current and coded into the proprietary aeronautical database of the GPS receiver and are unalterable by the pilot. This engages a series of safety precautions that may not otherwise be in Place.

All navigation database suppliers must hold a Type 2 Letter of Acceptance (LoA 2) or equivalent, issued for the GNSS equipment in accordance with EASA Opinion Number 01/2005 on “The acceptance of navigation database suppliers dated 14th January 2005, or equivalent; e.g., Federal Aviation Authority (FAA) Advisory Circular (AC) 20-153. [53]

In an attempt to eliminate critical errors, the minimum check on the integrity of an approach procedure should be made by the pilot (or aircraft operator) and include at least a check of the co-ordinates (Lat. & Long.) of the FAF and the track and distance to the Missed Approach Point (MAPt). For approaches with is vertical guidance, pilots need to check the correct altitude at the Final Approach Fix (FAF) and the descent gradient. The definition of the flight path between the Intermediate Fix (IF) and the Missed Approach Point (MAPt) shall not be modified by the flight crew in any circumstances. The database itself must also be the current issue and in date

Referring to Aeronautical Information Service [52] and above description, It is well known that The Final Approach of an Aircraft is one of the critical phases of a flight especially when the navigation aids are affected with some anomalies, Therefore, This study is acting as a solution to this critical phase and as a guideline to Pilot, having in mind that safety is the first priority.

Below is a chart of RNAV (GNSS) approach presentation, typically includes a choice of more than one Initial Approach Fix (IAF), often many miles from the destination. The intervening sections of the intermediate approach, delineated by a series of waypoints, replace the familiar ‘teardrop’ or reversal approach procedures from the overhead and lead directly to the FAF. The RNAV (GNSS) procedure is performed, therefore, by descending or ‘stepping down’ between each of these waypoints in turn, as opposed to flying a turning ‘let-down’ pattern from overhead the aerodrome

Therefore, there is a significant difference one distance display: Distance information to the next waypoint is presented to the pilots, instead of to a DME station that may be near the

runway. As a result of this, distance to the runway is not always immediately apparent, causing the pilots to lose awareness of the descent profile previously determined by comparison of the aircraft's level with the distance to touchdown. This means the pilots must be fully aware of the correct level to maintain to the next waypoint.

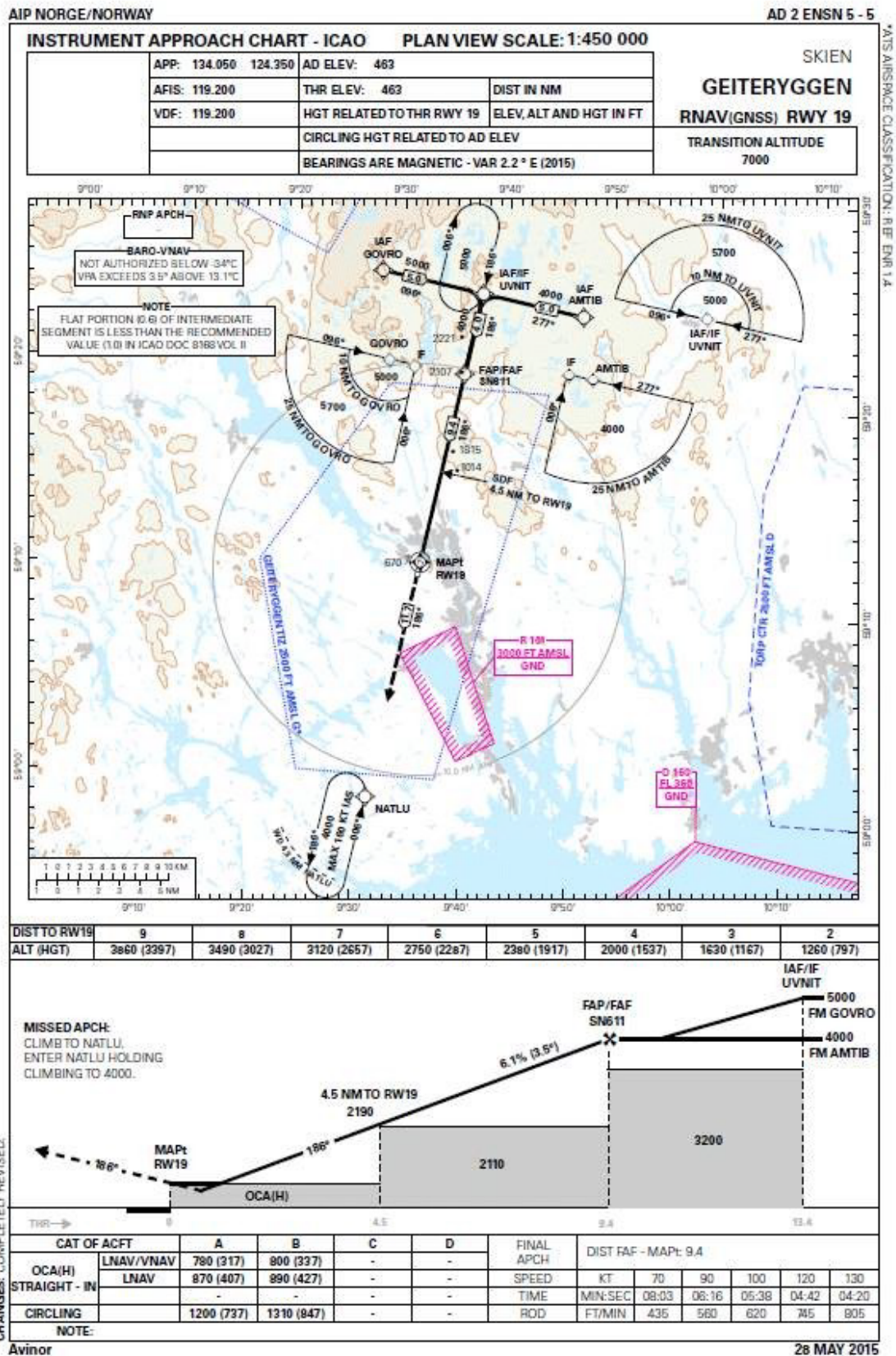

Figure 2. RNAV (GNSS) Instrument Approach chart, for illustration purposes only – not to be used for navigation

Further assurance for accurate and safe final approach procedure, GNSS constellation receiver's functions should be used to check the status of the satellite constellation. The receiver may also display information on the navigation status of the receiver itself (eg '3D Navigation') as well as the number of satellites in view, their signal strength, Estimated Position Error (EPE) of the system, Dilution of Precision (DOP) (3.7.2) and Horizontal Uncertainty Level (HUL) appropriate for the final phase of a flight as the main goal of this work present in Chapter4, [51]

3.4 Performance-Based Navigation PBN

The Performance-Based Navigation (PBN) is a concept which specifies that aircraft Area Navigation (RNAV) system performance requirements are defined with the terms of accuracy, integrity, availability, continuity, and functionality, which are selected for the intended operations in the context of a particular airspace concept. The PBN concept is different from sensor-based navigation. Indeed, performance requirements are identified in navigation specifications, which also identify the choice of navigation sensors used to meet the performance requirements. These navigation specifications are defined at a sufficient level of detail to enable a global harmonization by providing specific implementation guidance for all states and operator [13]

PBN offers several advantages compared to the sensor-specific method of developing airspace and obstacle clearance criteria [14] such as:

- Reducing the need to maintain sensor-specific routes and procedures, and their associated costs;
- Avoiding the need for developing sensor-specific operations with each new evolution of navigation systems, which would be cost-prohibitive;
- Allowing for more efficient use of airspace (route placement, fuel efficiency and noise abatement);
- Clarifying how RNAV systems are used;
- Simplifying the operational approval process for operators by providing a limited set of navigation specifications intended for global use;

The concept of PBN relies on RNAV systems and Required Navigation Performance (RNP) procedures and the difference between the two specifications is that on-board performance

monitoring and alerting is required for RNP but not for RNAV. RNAV requires independent performance monitoring of an aircraft's position.

Key terms and definitions are reminded here [13]:

- **Area Navigation (RNAV):** A method of navigation that permits aircraft operation on any desired flight path within the coverage of station-referenced navigation aids or with the limits of the capability of self-contained aids, or a combination of these.
- **Area Navigation Equipment:** Any combination of equipment used to provide RNAV guidance.
- **Required Navigation Performance (RNP) Systems:** An RNAV system that supports onboard performance monitoring and alerting.
- **Required Navigation Performance (RNP):** A statement of the navigation performance necessary for operation within a defined airspace.

It is mentioned that PBN is one of several enablers of an airspace concept. The others are Communications, ATS Surveillance and Air Traffic Management (ATM). The PBN concept is comprised of three components: The Navigation specification, the Navaid Infrastructure and the Navigation Application.

According to ICAO PBN Manual [13], the navigation performance requirements for RNAV operations specified by a performance-based approach are defined in terms of accuracy, integrity, availability, and continuity. These total system navigation requirements are specified for the Total System Error (TSE).

TSE is represented in Figure 3 below;

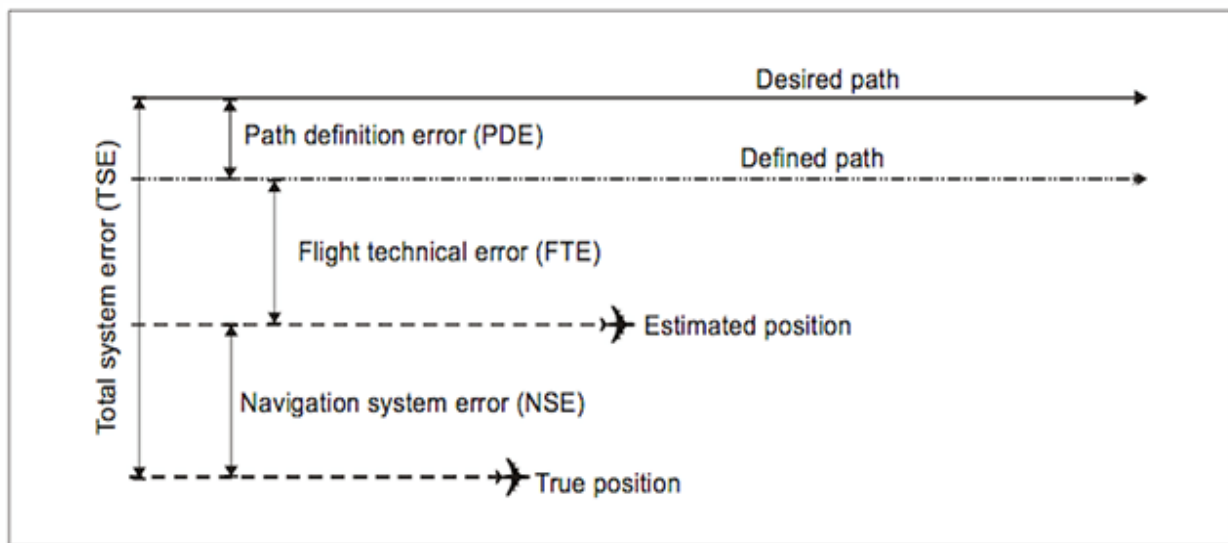

Figure 3. Total System Error [15]

The TSE is the difference between the true position and the estimated position. This error is equal to the vector sum of PDE, FTE and NSE.

Some important terms are defined below:

- **Defined Path:** The output of the path definition function.
- **Desired Path:** The path that the flight crew and air traffic control can expect the aircraft to fly, given a particular route or leg or transition.
- **Estimated Position:** The output of the position estimation function.
- **Path Steering Error (PSE):** The distance from the Estimated Position to the Defined Path. The PSE includes both FTE and displays error.
- **Flight Technical Error (FTE):** The accuracy with which the aircraft is controlled as measured by the indicated aircraft position with respect to the indicated command or desired position.
- **Path Definition Error (PDE):** The difference between the Defined Path and the Desired Path at a specific point.
- **Position Estimation Error (PEE):** The difference between the true position and the Estimated Position.

- **Total System Error (TSE):** The difference between true position and Desired Position. This error is equal to the vector sum of the Path Steering Error, Path Definition Error, and Position Estimation Error.

To support the PBN concept a reduced set of performance criteria have been identified so as to characterize the navigation performance equipment. These criteria are presented in the next section.

3.5 Navigation Performance Criteria

Operational requirements for GNSS based navigation are defined by four criteria/metrics which are accuracy, availability, continuity and integrity. The corresponding definitions which are reminded here can be found in [3].

3.5.1 Accuracy

Accuracy is the degree of conformance between the estimated or measured position and/or velocity of a platform at a given time and its true position and/or velocity. For characterizing the accuracy of the estimated quantity, ICAO has defined a 95% confidence level. It means that for any estimated position at a specific location, the probability that the position error is within the former requirement should be at least 95%. [3]

3.5.2 Availability

The availability of a navigation system is the ability of the system to provide the required function and performance at the initiation of the intended operation. The availability of GNSS is characterized by the portion of time the system is used for navigation and during which reliable navigation information is presented to the crew, autopilot, or other system managing the flight of the aircraft. [3]

3.5.3 Continuity

The continuity of a system is the capability of the total system (comprising all elements necessary to maintain aircraft position within the defined airspace) to perform its function

without interruption during the intended operation. Continuity relates to the capability of the navigation system to provide a navigation output with the specified accuracy and integrity throughout the intended operation, assuming that it was available at the start of the operation. The occurrence of navigation system alerts, either due to rare fault-free performance or to failures, constitute continuity failures. For En-route operations, since the duration of these operations are variable, the continuity requirement is specified as a probability on a per-hour basis. For both approach and landing operations, the continuity requirement is stated as a probability for a short exposure time.[3]

3.5.4 Integrity

Integrity is a measure of the trust that can be placed in the correctness of the information supplied by the total system. Integrity includes the ability of a system to provide timely and valid alerts to the user when the system must not be used for the intended operation (or phase of flight). Integrity requirements are defined with three parameters described below:

- **Integrity risk:** Is the probability of providing a signal that is out of tolerance without warning the user in a given period of time.
- **Time-to-Alert:** Is the maximum allowable elapsed time from the onset of a positioning failure until the equipment annunciates the alert.
- **Alert limits:** For each phase of flight, to ensure that the position error is acceptable, alert limits (Horizontal [or Lateral for approaches with vertical guidance] and Vertical) are defined and represent the largest position error which results in a safe operation. More details are given below:
 - *The Horizontal Alert Limit (HAL/LAL)* is the radius of a circle in the horizontal plane (the local plane tangent to the WGS-84 ellipsoid), with its center being at the true position, that describes the region that is required to contain the indicated horizontal position with the required probability for a particular navigation mode.
 - *The Vertical Alert Limit (VAL)* is half the length of a segment on the vertical axis (perpendicular to the horizontal plane of WGS-84 ellipsoid) with its center being at the true position that describes the region that is required to contain the

indicated vertical position with the required probability for a particular navigation mode.

The probability of non-integrity detection quantifies the integrity risk. It represents the probability that an error exceeds the alert limit without the user being informed within the time to alert. The values assigned to these three parameters depend on the specific application and intended operation. Thus, are determined by the ICAO.[3]

3.6 SIS Performance Requirements

The Signal in Space (SIS) is the combination of guidance signals arriving at the antenna of an aircraft. The SIS navigation performance requirements for radio navigation aids, including GNSS. In the case of GNSS, GNSS can be used during a given operation if the GNSS constellation(s), the GNSS ground sub-system(s) and the augmentation system(s) combined with a fault-free receiver meet the SIS navigation performance requirements for that operation. The fault-free receiver is assumed to be a receiver with nominal accuracy and time-to-alert performance. Such a receiver is assumed to have no failures that affect the integrity, availability and continuity performance [16]

In the case of GNSS, the MOPS for GPS and Galileo airborne receivers are developed by the RTCA and by EUROCAE bodies, respectively. ICAO develops SARPs for the other elements. More specifically, Volume 1 of ICAO Annex 10 [16] defines.

Table 3. SIS performance requirements [3]

Typical operation	Accuracy 95%		Integrity				Continuity	Availability
	Horizontal	Vertical	Integrity risk	Time to Alert	Horizontal Alert Limit	Vertical Alert Limit		
(APV-D)	16m	20m	$1 - 2 \times 10^{-7}/ap$	10s	40m	50m	$1 - 8 \times 10^{-6}/15s$	0.99 to 0.99999

(APV-II)	16m	8m	$1 - 2 \times 10^{-7}/ap$ p	6s	40m	20m	$1 - 8 \times 10^{-6}/15s$	0.99 to 0.99999
Cat-I	16m	6-4m	$1 - 2 \times 10^{-7}/ap$ p	6s	40m	15-10m	$1 - 8 \times 10^{-6}/15s$	0.99 to 0.99999

Referring to the table above, the following notes are presented;

- The 95th percentile values for GNSS position errors are those required for the intended operation at the lowest height above threshold (HAT) if applicable.
- The integrity requirement includes an alert limit against which the requirement can be assessed. For Category I precision approach, a vertical alert limit (VAL) greater than 10 m for a specific system design may only be used if a system-specific safety analysis has been completed.
- The accuracy and time-to-alert requirements include the nominal performance of a fault-free receiver
- A range of values is specified for Category I precision approach. The 4.0 m (13 feet) requirement is based upon ILS specifications and represents a conservative derivation from these specifications.
- The terms APV-I and APV-II refer to two levels of GNSS approach and landing operations with vertical guidance (APV) and these terms are not necessarily intended to be used operationally.[16]

PART II

3.7 GNSS Constellations, GNSS Signals measurement model and Augmentation Systems

3.7.1 GNSS Constellations

Larry Niven an “American science fiction author”, suggested that if the dinosaurs had had a space program they could have intercepted and deflected the asteroid that some think may have hit the earth and led to the extinction of the dinosaurs. Unlike the dinosaurs,

several countries now have existing or planned space programs that include the implementation of national or regional Global Navigation Satellite Systems. [17]

Global Navigation Satellite Systems (GNSS) include constellations of Earth-orbiting satellites that broadcast their locations in space and time, of networks of ground control stations, and of receivers that calculate ground positions by trilateration. GNSS is used in all forms of transportation: space stations, aviation, maritime, rail, road, and mass transit. Positioning, navigation, and timing (PNT) play a critical role in telecommunications, land surveying, law enforcement, emergency response, precision agriculture, mining, finance, scientific research and so on. They are used to control computer networks, air traffic, power grids and more [18] There are different GNSS constellations that are currently operational or under development:

GPS (American system)	BEIDOU (Chinese system)
GALILEO (European system)	QZSS (Japanese system)
GLONASS (Russian System)	IRNSS (Indian system)

The GNSS constellations considered in this project are GPS (American System) and Galileo (European System).

3.7.1.1 GPS

The Global Positioning System (GPS) is a network of about 32 satellites orbiting the Earth at an altitude of 20,000 km, GPS service provides users with approximately 7.8-meter accuracy, 95% of the time, anywhere on or near the surface of the earth. To accomplish this, each of the 32 satellites emits signals to receivers that determine their location by computing the difference between the time that a signal is sent and the time it is received. GPS satellites carry atomic clocks that provide extremely accurate time. [19] Therefore, the GPS is composed of three segments defined as Space Segment, User Segment, and Control Segment.

The space segment [7] is the satellite part of the positioning system. The United States' Global Positioning System (GPS) [20] space segment consists of up to 32 (MEO) satellites in six different orbital places, with the exact number of satellites varying as older satellites are retired and replaced. GPS became operational in July 1995 with the following noteworthy modifications:

- Modernization of GPS II: GPS L2C since the end of 2005, GPS L5 in 2010
- With the adding of L1C, GPS III could be operational in 2021
- New military signal M-code on L1 and L2

Today, several signals are available for civil aviation application named GPS L1 C/A and GPS L5 (in the future L1C will be available and is described only for information purpose in this part). These signals are the GNSS signals located in the specific frequency bands named Aeronautical Radio Navigation Services (ARNS). ARNS bands are reserved for aeronautical systems and particularly protected from in-band interference by regulation authorities.[20]

The characteristics of these available GPS signals for Civil Aviation (frequency occupation and structure) are described in the following table extracted from [20]

Table 4. GPS Signals for Civil Aviation

Constellation	Signal	Modulation	Code Length (ms)	Chip rate (Mcps)	Navigation Data (sps)	Secondary Code Length
GPS	L1 C/A	BPSK(1)	1023	1.023	50	No
	L1C-I	TMBOC (614/33)	10230	1.023	100	No
	L1C-Q		10230	1.023	Pilot	1800 bits
	L5-I	QPSK(10)	10230	10.23	1000	NH-10 (10 bits)
	L5-Q		10230	10.23	Pilot	NH-20 (20 bits)

The User Segment [21] includes millions of GPS receivers (military or civilians). These receivers can be static on Earth, or mobile in a vehicle on Earth, in an aircraft or a spacecraft. They permanently collect GPS signals and process them to compute the position and velocity of the user. The role of the Control Segment [21] is to ensure the surveillance of the received signal characteristics, to compute the ephemeris data and the satellite clock corrections, and to

download the navigation message into the satellite's payload. Therefore, the control segment is composed of 4 major subsystems:

- The Master Control Station (MCS, soon replaced by a New Master Control Station) located in Colorado which is responsible for constellation command and control,
- A Back-up Master Control Station (BMCS, soon replaced by an Alternate Master Control Station), a network of 4 ground antennas;
- A network of monitor stations globally-distributed.



Figure 4. GPS

The system has demonstrated exceptional reliability, but like all systems, it has suffered a technical and human failure. The satellite clocks are critical to the integrity of the system and are subject to regular intervention. Furthermore, the designs for receivers vary; particularly in the software that manages the satellite data for navigation. It is for these reasons that GPS must be used with knowledge and caution when used as the primary steering reference, for flight critical applications, such as instrument approach. [51]

Timing is everything in GNSS, and each satellite has up to four atomic clocks with accuracies measured in the order of thousandths of millionths of a second. Master control stations and

monitoring stations around the world, track and manage the satellites, relaying critical correctional data to them. [51]

3.7.1.2 Galileo

The European Union and European Space Agency agreed in March 2002 to introduce their own alternative to GPS, called the Galileo positioning system. It has made significant progress in recent years. Eighteen Galileo satellites are now orbiting the Earth, and the supporting ground station infrastructure is working well. Today signals of Galileo are available for Civil Aviation.

The characteristics of these available Galileo signals for Civil Aviation (frequency occupation and structure) are described in the following table extracted from [20]

Table 5. GALILEO Signals for Civil Aviation

Constellation	Signal	Modulation	Code Length (ms)	Chip rate (Mcps)	Navigation Data (sps)	Secondary Code Length
GALILEO	E1B	CBOC(6,1,1/1)	4092	1.023	250	No
	E1C		4092	1.023	Pilot	Primaryx25(100ms)
	E5A-I	QPSK(10)	10230	10.23	50	Primary x20(20ms)
	E5A-Q		10230	10.23	Pilot	Primary x100 (100ms)
	E5B-I	QPSK(10)	10230	10.23	250	Primary x4 (4ms)
	E5B-Q		10230	10.23	Pilot	Primary x100 (100ms)

This Master's work is focusing on the above signals combined for better reliability and accuracy in the Air Navigation system in the following sections.

3.7.2 GNSS Signals

The GNSS satellites continuously transmit navigation signals in two or more frequencies in L-band. These signals contain ranging codes and navigation data to allow the users to compute the travelling time from a satellite to a receiver and the satellite coordinates at any epoch. The main signal components are described as follows:

- **Carrier:** Radio frequency sinusoidal signal at a given frequency.
- **Ranging code:** Sequences of 0s and 1s (zeroes and ones), which allow the receiver to determine the travel time of radio signal from satellite to receiver. They are called Pseudo-Random Noise (PRN) sequences or PRN codes
- **Navigation data:** A binary-coded message providing information on the satellite ephemeris (Keplerian elements or satellite position and velocity), clock bias parameters, almanac (with a reduced accuracy ephemeris data set), satellite health status, and other complementary information. [23]

The current and future of GPS and Galileo signals that will be available for civil aviation applications will use GPS modernization and the Galileo development. For the signals to be well seen the geometry of the satellite should be mentioned to determine the position of satellites, this core is known as Geometric Dilution of Precision (GDOP) or Dilution of Precision (DOP). Positions with a lower DOP value generally constitute better measurement results than those with higher DOP. A low DOP value indicates a higher probability of accuracy. DOP only depends on the position of the satellites: how many satellites you can see, how high they are in the sky, and the bearing towards them.

There are factors determining the total GDOP (geometric DOP) for a set of satellites;

- PDOP (positional DOP)
- HDOP (horizontal DOP)
- VDOP (vertical DOP)
- TDOP (time DOP).

For finding how GDOP is measuring accuracy for positioning systems, below formula can be used:

$$GDOP = \frac{\sqrt{\sigma^2 E + \sigma^2 N + \sigma^2 U + \sigma^2 T}}{\sigma}$$

Equation 1. GDOP measure accuracy in 3D position and time

Where

$\sigma^2 E$: C0-Variance of East-components

$\sigma^2 N$: C0-Variance of East-components

$\sigma^2 U$: C0-Variance of East-components

$\sigma^2 T$: C0-Variance of East-components

σ : Collective standard deviation of pseudo-range, residual model, receiver noise, satellite clock, ephemeris, multi-path, selective availability, and atmospheric error (in terms of distance) OR UERE (User Equivalent Residual Error Matrix).

To obtain the position and time error variances, the covariance matrix of the position and time correction errors is computed. This matrix has the form. Where V_x , V_y , V_z and V_T are the position and time variances and the off-diagonal elements are functions of the correlations between the errors [40]

$$Cov(x) = \begin{bmatrix} V_x & & & \\ & V_y & & \\ & & V_z & \\ & & & V_T \end{bmatrix}$$

Equation 2. Covariance matrix of the position and time correction errors

GPS and Galileo signals are located in the Radio Navigation Satellite Services (RNSS) frequency bands. The current and future GPS and Galileo signals that will be available for civil aviation applications are located in the Aeronautical Radio Navigation Services (ARNS) frequency bands. ARNS bands are reserved for aeronautical systems and are protected from in-band interference by regulation authorities. RNSS frequency bands, ARNS frequency bands and GPS and Galileo frequency bands are represented in Figure 3

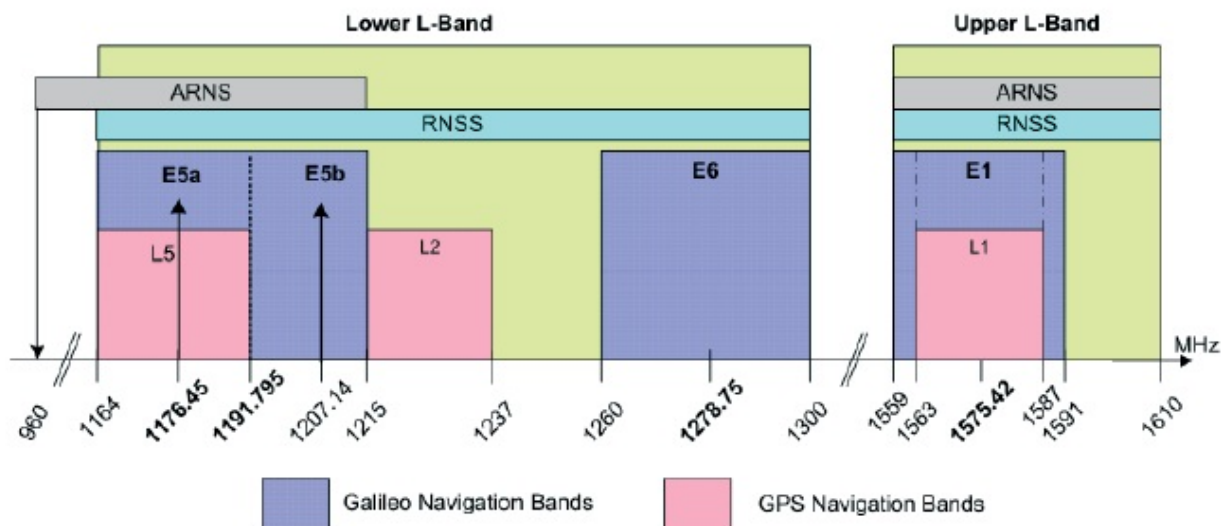

Figure 5. GPS and Galileo frequency bands [22]

3.7.3 GNSS Pseudo-Range Measurement Model

The Pseudo-Range is the pseudo distance between a satellite and a navigation satellite receiver, for instance, Global Positioning System (GPS) receivers. The pseudo ranges of each satellite are obtained by multiplying the speed of light by the time the signal has taken from the satellite to the receiver.

As the goal of this work, to analyze the impact of weather most general the atmospheric weather on the GNSS navigation, this paper is taking a brief look at the positioning of the satellites and the delays caused by the Atmospheric layers (Troposphere and Ionosphere).

The Pseudo-range from receive μ to satellites, $\rho^{(s)}$ can be expressed as:

$$\rho^{(s)} = r^{(s)} + c\Delta t_{\mu}^{(s)} + I + T + \varepsilon$$

Equation 3. Pseudo-range model

Where: $r^{(s)}$: True range to satellite S

c : The speed of light

$\Delta t_{\mu}^{(s)}$: Deviation between the satellite clock and the receiver clock $\Delta t_{\mu}^{(s)} = \Delta t_{\mu} - \Delta t^{(s)}$

I : Ionospheric delay

T : Tropospheric delays

ε : The signal propagation delays and measurements errors

Note that subscripts (e.g., u) reflect receiver specific values, while superscripts identify individual satellites; these are not powers of (s).

This pseudo range measurement can be corrected by $\Delta\hat{t}^{(s)}$ which is a correction of the deviation between satellite clock and GPS time given by the satellite signal and applied to each $\rho^{(s)}$ by doing so, Geometric range will be used;

$$r^{(s)} = \sqrt{(x^{(s)} - x)^2 + (y^{(s)} - y)^2 + (z^{(s)} - z)^2}$$

Equation 4. Geometric Range

Which is the Euclidean distance between a receiver at position (x, y, z) and the satellite, s, at position $\rho^{(s)} = x^{(s)}y^{(s)}z^{(s)}$ Note that this range $r^{(s)}$ is also time dependent,

Therefore, the corrected pseudo range measurement model can also be expressed as:

$$r^{(s)} = \sqrt{(x^{(s)} - x)^2 + (y^{(s)} - y)^2 + (z^{(s)} - z)^2 + c \times \Delta t_{\mu} + \varepsilon}$$

Equation 5. Corrected Pseudo-range measurement model

Where x, y, z, are 3-coordinates, Δt_{μ} is unknown ε now captures all delays including ionosphere and atmosphere delays given separately before. More details in Appendix A

3.7.4 GNSS Augmentation Systems

In order to meet the civil aviation operational requirements in terms of accuracy, integrity, availability and continuity; the aviation community has standardized augmentation systems to correct the GNSS pseudo-range measurements and to monitor the received SIS.

Three kinds of GNSS augmentation systems are described below.

1. SBASs are the wide coverage augmentation system in which the user receives augmentation information from a satellite-based transmitter [3]. SBAS consists of the satellite subsystems, the ground subsystem and the airborne subsystem. The ground subsystem collects measurements from the core constellation satellites and the SBAS geostationary satellites and computes differential corrections and SIS integrity data. It transmits these data to the airborne subsystem via geostationary satellites. SBAS allows correcting each pseudo-range measurements by a satellite clock correction term, an ephemeris correction term and an ionospheric correction term [24]
2. GBASs provide locally relevant pseudo-range corrections and integrity monitoring for GNSS ranging sources [3]. GBAS consists of the satellite subsystems, the ground subsystem and the airborne subsystem.

The ground subsystem consists of GNSS reference receivers and a GBAS ground facility close to the airport and provides ephemeris and satellite clock errors, tropospheric errors and ionospheric errors differential corrections to the airborne receiver. The tropospheric and ionospheric delays are partially mitigated by the differential corrections since the spatial de-correlation between the reference receivers and the airborne receivers are responsible for small residual troposphere and ionosphere errors. The ground subsystem also monitors the integrity of the space and ground systems and provides differential correction integrity data to the airborne receiver.

3. ABAS is an augmentation system that augments and/or integrates the information obtained from the other GNSS elements with information available on board the aircraft [3]. ABAS monitors the integrity of the position solution using:
 - Redundant information from GNSS information (multiple range measurements) through RAIM algorithms,
 - Redundant information from additional on-board sensors (e.g. barometric altimeter, clock and inertial navigation system (INS)) through Aircraft Autonomous Integrity Monitoring (AAIM) algorithms.

3.7.6 Integrity Navigation System Performance

Integrity relates to the trust that can be placed in the correctness of information supplied by a navigation system. It includes the ability of the navigation system to provide timely warnings to users when the system fails to meet its stated accuracy. Specifically, a navigation system is required to deliver a warning (alarm) when the error in the derived user position solution exceeds an allowable level (alarm limit). This warning must be issued to the user within a given period of time (time-to-alarm) and with a given probability (integrity risk). The two main approaches to monitoring the integrity of satellite navigation systems are Receiver Autonomous Integrity Monitoring (RAIM), and monitoring based on an independent network of integrity monitoring stations and a dedicated Ground Integrity Channel (GIC). More recently Satellite Autonomous Integrity Monitoring (SAIM) methods have also been investigated [25]. Therefore, integrity performance is a “per operation” This means that the integrity performance requirement must be met individually for every operation [25]. In addition, the integrity requirement must be met for every epoch t_i of each operation. In other words, for every epoch t_i the probability of loss of integrity must be below the allowable integrity risk P_{IR}

The loss of integrity, or HMI, occurs when a position error is larger than the alert limit, or the current protection level, without any indication of the error within the TTA for the applicable phase of flight [16]. The TTA is the maximum allowable elapsed time from the onset of a positioning failure until the equipment annunciates the alert [16]. A positioning is meant to happen whenever the position error exceeds the applicable alert limit. By means of HMI definition, the probability of loss of integrity at time epoch t_i of an operation can be formulated as:

$$P_{HMI,t_i} = \left[\frac{\left(\left| \frac{\varepsilon_p(t_i)}{PF} \right| > HAL \right) \& (no\ detection\ with\ TTA)}{HMI} \right]$$

Equation 6. The probability of loss of integrity at time epoch t_i

Where $\varepsilon_p(t_i)$ represents the norm of the horizontal position error at t_i for every time epoch t_i of every operation, the integrity monitoring system must be designed to meet the following constraint:

$$P_{IR} \geq P_{HMI,t_i}$$

Equation 7. The probability of HMI at time epoch t_i

Where P_{IR} is the allowed probability of providing a position that is out of tolerance without warning the user within the TTA.

3.7.6 Integrity Monitoring

Integrity monitoring refers to the ability to timely warn the user or terminate the signal function instantly when the navigation system error exceeds the predefined threshold. For aviation users, the integrity of the navigation system is essential. Today, integrity monitoring in aviation is implemented in two different ways, at the system level or at the user level. At the system level, two types of external augmentation systems can be distinguished, Space-Based Augmentation Systems (SBAS), and Ground-Based Augmentation Systems (GBAS), both are Differential GPS systems (DGPS).[27]

SBAS and GBAS develop corrections that improve the accuracy of the measurements and generate real-time error bounds. These bounds are called Protection Levels (PL) and must exceed the actual error under all conditions with very high probability. SBAS and GBAS are both very powerful means of guaranteeing integrity, but they present the drawback of needing a very complex and costly infrastructure.

At the user level the GNSS integrity can be monitored by exploiting the redundancy of the GNSS signals as collected at the receiver. This is done by performing calculations within the user equipment itself to check the consistency of the measurements. This method is known as Receiver Autonomous Integrity Monitoring (RAIM). RAIM is possible as long as a number of observations larger than the minimum necessary for a position fix are available. RAIM strictly relies on the strength of the satellite geometry. With the deployment of the new GNSS constellations many more satellite signals will soon be available: this will increase the redundancy of measurements and the RAIM power. [27]

In the beginning, most RAIM algorithms have been developed considering only single satellite constellation [27] and least squares estimation. The residual of the measurements is the basic variable to identify the integrity, thus the redundant measurements are necessary. It is not so difficult to realize the RAIM performance if the residuals reflect the measurement error or the

satellite status reliably. In the situation of single satellite constellation, the average visible satellite is about 7–8 which cannot provide enough redundancy.

In this work, multiple constellations was used and provide us abundant measurements for improving the positioning accuracy, and to provide more possibilities for monitoring the user's integrity. The benefits of the multi-constellation are demonstrated [28]. The ICAO Advanced RAIM (ARAIM) working group has been promoting the development of RAIM algorithm for multiple constellations and multiple faults for aviation. The integrity monitoring for two satellites faults was discussed [29] A group separation (GS) RAIM method was designed for the dual constellation, such as GPS and Galileo [30]. Three solutions were calculated, one was based on all-in-view satellite (including GPS and Galileo), and the other two solutions use GPS or Galileo respectively. The separation between the all-in-view solution and either of the independent system was used as a test statistic. If anyone of the two statistics exceeds a detection threshold, the observation from that system will be abandoned entirely.

This GS method can handle multiple faults within one of the systems. It's obvious that the GS method did not take full advantage of the observations. There is a bargain between integrity and precision. A modification of the GS method called optimally weighted average solution (OWAS) was proposed later [31], the position solution of this method was the weighted average of the two individual systems. Both methods assume that multiple faults occur in one system, while the other system is healthy. A detailed explanation of an optimized multiple hypothesis solution separations (MHSS) algorithm for RAIM was given, all the possible fault mode was considered to detect and exclude the fault satellite [32]. Though these fault detection and exclusion procedure are used in GNSS situation by considering all the possible fault modes, its efficiency is low because one has no foreknowledge about the number of faults [33].

Considering the available dynamic model, they developed a RAIM scheme based on Kalman filtering [34] These methods are based on Baarda outlier detection and identification procedure [35] If a failure satellite creates a significant outlier, the residuals of measurements based on the least squares estimates may be seriously contaminated, the corresponding variance scale may be very large, in this case, the RAIM detection may fail.

A RAIM needs reference coordinates to calculate the measurement errors. Usually, the raw observations are scalar pseudo-ranges of satellites to receiver lines (equation 3). An alternative

approach for RAIM is presented in below section based on multiple GNSS and least square estimation.

In practice, we usually use the residuals of the measurements as variables to identify the problematic satellites or measurement outliers. Assume that the raw measurement and estimated measurement vectors are L and \hat{L} respectively, the residual vector is then expressed as

$$V = \hat{L} - L$$

Equation 8. Residual vector

V : Residual vector

\hat{L} : Estimated measurement vector

L : Raw measurement vector

Collecting observations from n satellites, we obtain n observation equations

$$V = A\delta\hat{X} - \varepsilon$$

Equation 9. Residue vector with matrix

V : Residual vector

A : Design matrix

$\delta\hat{X}$: Estimated correction vector of the approximate receiver coordinate and the clock offset parameters of different systems

ε : Vector of measurements minus the calculated ones based on the approximated receive coordinate

Considering the differences between different satellite navigation systems, it can be expressed as [33]

$$A = \begin{bmatrix} a_x^{gps,1} & a_y^{gps,1} & a_z^{gps,1} & 1 & 0 \\ \vdots & \vdots & \vdots & \vdots & \vdots \\ a_x^{gps,n1} & a_y^{gps,n1} & a_z^{gps,n1} & 1 & 0 \\ a_x^{gal,n1+1} & a_y^{gal,n1+1} & a_z^{gal,n1+1} & 0 & 1 \\ \vdots & \vdots & \vdots & \vdots & \vdots \\ a_x^{gal,n} & a_y^{gal,n} & a_z^{gal,n} & 0 & 1 \end{bmatrix}$$

Equation 10 (Matrix). Satellite navigation system matrix

Where a is expressed:

$$a_x = \frac{x^i - x^u}{[(x^i - x^u)^2 + (y^i - y^u)^2 + (z^i - z^u)^2]^{\frac{1}{2}}}$$

$$a_y = \frac{y^i - y^u}{[(x^i - x^u)^2 + (y^i - y^u)^2 + (z^i - z^u)^2]^{\frac{1}{2}}}$$

$$a_z = \frac{z^i - z^u}{[(x^i - x^u)^2 + (y^i - y^u)^2 + (z^i - z^u)^2]^{\frac{1}{2}}}$$

Equation 11. Expression matrix

If the least squares principle is applied, then the estimation $\delta \hat{X}$ is obtained as

$$\delta \hat{X} = (A^T P A)^{-1} A^T P \varepsilon = N^{-1} A^T P \varepsilon$$

Equation 12. Estimated correction vector

With $N = A^T P A^{-1}$, P denote the weight matrix of measurement

$$P = \begin{bmatrix} 1/\sigma_1^3 & 0 & \dots & 0 \\ 0 & 1/\sigma_2^3 & \dots & 0 \\ \vdots & \vdots & \ddots & \vdots \\ 0 & 0 & \dots & 1/\sigma_n^3 \end{bmatrix}$$

Equation 13 (Matrix). Weight matrix of measurement

The residual vector follows

$$V = A\delta\hat{X} - \varepsilon = (AN^{-1}A^T P - I)\varepsilon = (H - I)\varepsilon$$

Equation 14. Residual vector with an idempotent matrix

With $H = AN^{-1}A^T P$ is an idempotent matrix

That is $H = H$

Therefore, the following test statistic for the least square based RAIM can be used

$$test = \sqrt{V^T P V}$$

Equation 15. Least square based RAIM test

Assume that

V : Normally distributed random variable with zero mean

T : The threshold which can be calculated by the number of satellite N and the possibility of false alarm

P : The weight matrix of measurements

3.7.7 Protection Level (PL)

One means to ensure that the allocated integrity budgets are met is to compute a Protection Level. A protection level is a bound with its centre being at the true position that describes the region assured to contain the indicated position within the relevant domain. There are defined for the horizontal domain for operations from en-route down to NPA approaches as HPL, for the lateral and vertical domain for approaches with vertical guidance respectively as LPL and VPL.

Protection Levels are functions of the satellites and user geometry and the expected error characteristics: they are not affected by actual measurements. Their value is predictable given reasonable assumptions regarding the expected error characteristics. The system assures that, in the absence of an integrity alert, the estimated position is within the volume defined by the HPL/LPL and VPL in compliance with the integrity risk [26]

$$P\{[(|(x - \hat{x})_H| > HAL/LAL) \text{ or } (|(x - \hat{x})_v| > VAL)] \text{ and } [\text{no alert}]\} \leq P_{int}$$

Equation 16. Estimated Position

Where

$(x - \hat{x})_H$ and $|(x - \hat{x})_v|$ are the horizontal and vertical positioning errors

When any of the protection levels exceeds the alert limit, the integrity monitoring system is declared unavailable because it is not able to assure that the estimated position is within the volume defined by the HAL (or LAL) and VAL specified in the SIS requirements [26]

$(HPL \leq HAL)$ or $(LPL \leq LAL)$ and $(VPL \leq VAL)$: Available integrity monitoring

$(HPL > HAL)$ or $(LPL > LAL)$ and $(VPL > VAL)$: Unavailable integrity monitoring

The following figure illustrates the relationship between Protection levels and Alert levels.

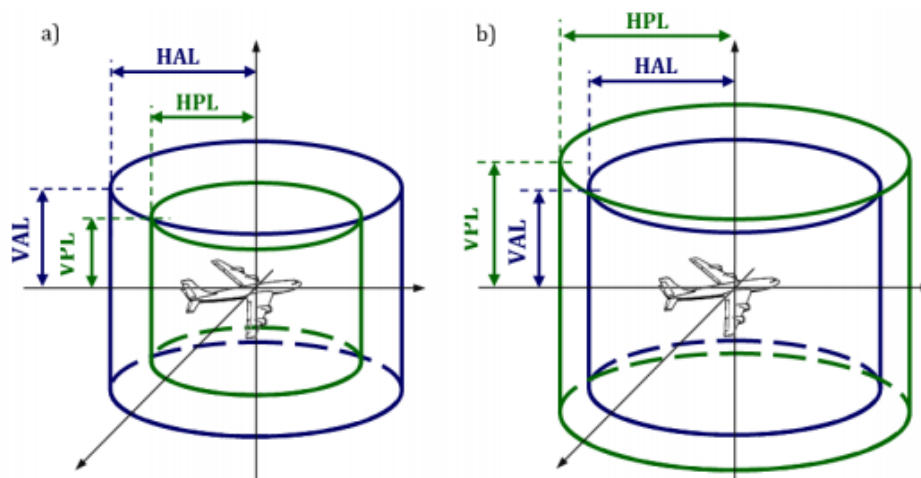

Figure 6. Relationship between alert and protection levels: a) available integrity monitoring system, b) unavailable integrity monitoring system [26]

3.8 Weather Classifications and the impact on GNSS signals

The characteristics and behavior of the Earth's weather is one of the perturbation of GNSS signals. In this Master's work, atmospheric weather is being discussed as one of the impact of the GNSS signals loss.

The atmosphere is the space around the Earth which is filled by a mixture of gasses held against the Earth by the force of gravity. This mixture of gasses we call it air. Because the Earth spins on its axis, and because the surface temperature is greater at the equator than at the poles, the atmosphere extends further out into space at the equator than at the poles. Air Density decreases with increasing altitude.

The atmosphere is divided vertically into four layers:

- Troposphere
- Stratosphere
- Mesosphere and
- Thermosphere

In this section, two layers have been focused on as the most essential and critical layers for signals perturbations: Troposphere and the most common known as Ionosphere from about 60 km (37 mi) to 1,000 km (620 mi) altitude, a region that includes Thermosphere and parts of the mesosphere as shown in the figure 5.

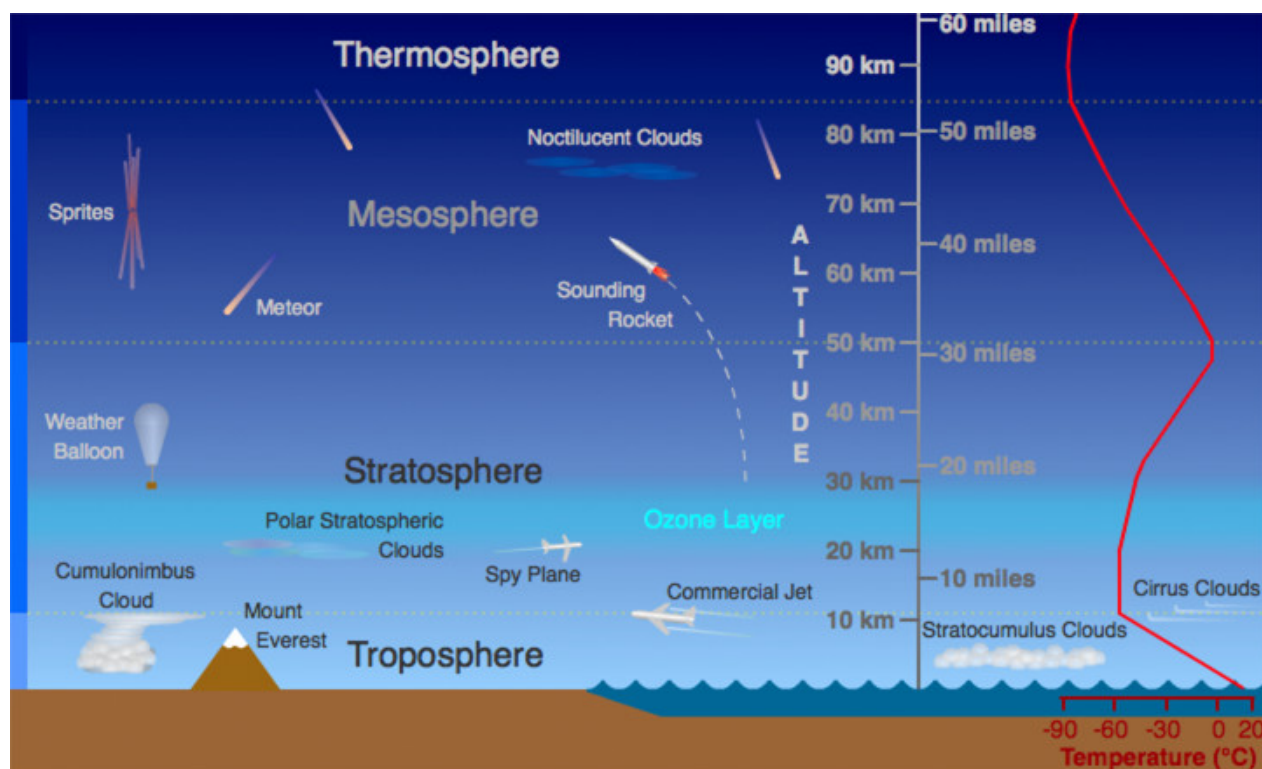

Figure 7. Atmospheric layers [36]

3.8.1 Troposphere

The troposphere is the lowest region of Earth's atmosphere ranging from 0 to 50km. It is the seat of all meteorological phenomena's (clouds, rain, hydrometeors...) and contains approximately 75% of the atmosphere's mass and almost all (99%) of its water vapour and aerosols.

When travelling from the GNSS satellites to the receiving antennas located on the Earth, the radio-frequency signals emitted by Global Navigation Satellite Systems (such as GPS, GLONASS and Galileo) traverse and interact with the Earth's atmosphere [37] The main interaction that links troposphere to the electromagnetic signal propagation is atmospheric refraction. Refraction is the phenomenon of the change of direction and speed of propagation of an electromagnetic wave as it passes from one medium to another. The atmospheric refraction effect on GNSS signals as shown on the figure 6.

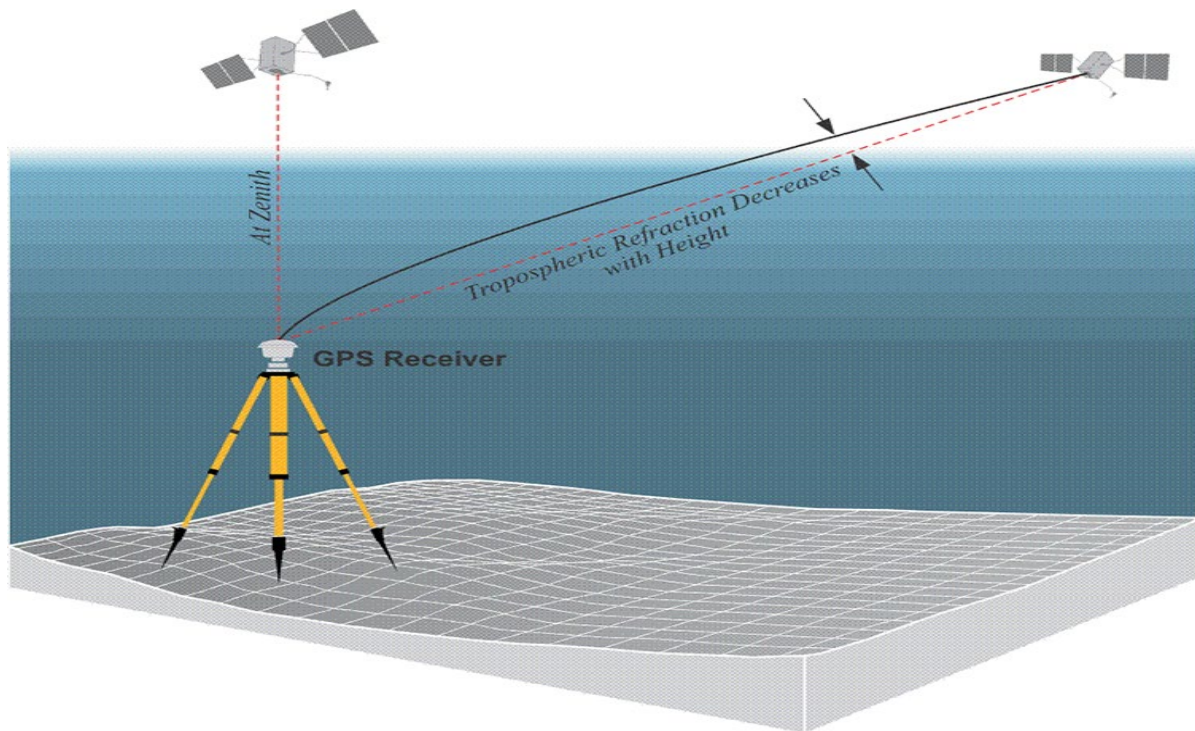

Figure 8. Tropospheric effects [37]

To model the effect of the troposphere from ground up to 50 km altitude on the signal delay, the density of the atmosphere and the satellite elevation regarding the DCP shall be considered and the signal delay rate due to the troposphere was calculated by: [38]

$$\dot{R}_t = -(T_{ZH} + T_{ZW}) \frac{\cos y}{\sin^2 y} \dot{y}$$

Equation 17. Signal delay rate due to troposphere

\dot{R}_t : Signal Delay

T_{ZH} : Dry component

T_{ZW} : Wet component

y : Elevation angle

\dot{y} : Elevation rate Angle

The dry component contributes most of the delay, perhaps 80% to 90%, is closely correlated to the atmospheric pressure. The dry component can be more easily estimated than the wet

component. It is fortunate that the dry component contributes the larger portion of range error in the troposphere, because the size of the delay attributable to the wet component depends on the highly variable water vapor distribution in the atmosphere. Even though the wet component of the troposphere is nearer to the Earth's surface, measurements of temperature and humidity are not strong indicators of conditions on the path between the receiver and the satellite. While instruments that can provide some idea of the conditions along the line between the satellite and the receiver are somewhat more helpful in modeling the tropospheric effect, the high cost of sending water vapor radiometers and radiosondes aloft generally restricts their use to only the most high-precision GPS work. In most cases, this aspect must remain in the purview of mathematical modeling [39]

3.8.2 Ionosphere

The Earth ionosphere named so because it is ionized by solar radiation. The ionosphere is thus a shell of electrons and electrically charged atoms and molecules that surrounds the Earth, stretching from a height of about 50 km to more than 1000 km. It comprised of negatively charged electrons which remain free for long periods before being captured by positive ions that give them to be the first part of the atmosphere that the signal encounters as it leaves the satellite.

The severity of the ionosphere's effect on a GNSS signal depends on the amount of time that signal spends traveling through it. A signal originating from a satellite near the observer's horizon must pass through a larger amount of the ionosphere to reach the receiver than does a signal from a satellite near the observer's zenith. In other words, the longer the signal is in the ionosphere, the greater the ionosphere's effect on it.

The most important thing about the ionosphere to the GNSS signal is that it attenuates, or slows, the signal, depending on the density of the layer of atmosphere. The ionosphere is not homogeneous and unchanging. It is in constant flux. Therefore, it's impossible to have a correction that's static.

The ionosphere changes. Its behavior in one region of the earth is liable to be unlike its behavior in another, Ionosphere disturbances can be particularly harsh in the polar regions, but the highest TEC (Total Electron Content) values and the widest variations in the horizontal

gradients occur in the band of about 60° of geomagnetic latitude. That band lies 30° norths and 30° south of the earth's magnetic equator [39]

Another consequence of the dispersive nature of the ionosphere is that the apparent time delay for a higher frequency carrier wave is less than it is for a lower frequency wave. That means that L1, 1575.42 MHz, is not affected as much as L2, 1227.60 MHz, and L2 is not affected as much as L5, 1176.45MHz

This fact provides one of the greatest advantages of a dual-frequency receiver over the single-frequency receivers. The separations between the L1 and L2 frequencies (347.82 MHz), the L1 and L5 frequencies (398.97 MHz) and even the L2 and L5 frequencies (51.15 MHz) are large enough to facilitate estimation of the ionospheric group delay. Therefore, by tracking all the carriers, a multiple-frequency receiver can model and remove, not all, but a significant portion of the ionospheric bias [9]

The frequency dependence of the ionospheric effect is described by the following expression

$$V = \frac{40.3}{cf^2} \cdot TEC$$

Equation 18. Ionospheric delay

Where

V : The ionosphere delay

c : The speed of light in meters per second

f : The frequency of the signal in HZ

TEC : The quantity of free electrons per square meter

As the formula illustrates, the time delay is inversely proportional to the square of the frequency; in other words, the higher the frequency, the less the delay.

The total electron content between the satellite and the receiver can be expressed as:

$$TEC = \int_{Satellite}^{receiver} N(h)dh$$

Equation 19. TEC Equation

Where:

$N(h)$: is free electron density at the height h above the Earth's surface (the vertical profile of the ionosphere)

The TEC is the key parameter for the mitigation of the ionospheric error. The ionospheric delay causes ranging errors in the zenith direction that vary typically from 1-3 m at night to 5-15 m in the mid-afternoon [54,55,56]. For the satellites at low elevations the maximum delay can be even more than 100 m, depending mostly on the solar activity. The influence of the ionospheric layers on radio signal propagation is frequency dependent, and different frequencies have different signal delays, what is obvious from the equation (13). This characteristic of the ionosphere can be efficiently used to mitigate the signal delay

Therefore, Both the ionosphere and the troposphere refract GNSS satellite signals and are sources of error for GNSS performance and it needs to be properly corrected or mitigated in order to achieve high precision positioning or time and frequency transfer.

3.8.3 Atmospheric Error Correction

3.8.3.1 Tropospheric

We can use several strategies to correct the errors caused by the tropospheric effects:

- Ignore the tropospheric delay
- Presume and use a constant value of the zenith path delay
- Estimate the delay from the surface meteorological observation data
- Predict the delay from empirically-derived climatologically data
- Use additional information provided by a differential GPS station

3.8.3.2 Ionospheric

We can use several strategies to correct the errors caused by the Ionospheric effects:

- Measuring the difference of the GNSS signal delay at two transmitted frequencies and calculating the delay in real time
- Using mathematical models for the calculation of the GNSS signal delay
- Using additional information provided by ground and space-based augmentations - differential GPS/GNSS

PART III. General Process of GNSS Simulation

3.9 Simulation Equipment's

The main objective of this Master's work/project is to promote the combined use of GPS and Galileo signals in aviation most likely as the guidance of the final approach of an aircraft taking into account the influence of weather (Atmospheric weather). Thus, simulation of GNSS were generated by the use of essential equipment that are mentioned below.

3.9.1. Personal Computer (PC)

Personal Computer is a cost-effective computer designed to perform different tasks with input and output platform. The main role of a computer is to keep and process data or information in a very simplified mode. In this Master's paper PC was used to gather and process the information received from GNSS antenna. Used PC is shown on the figure 9

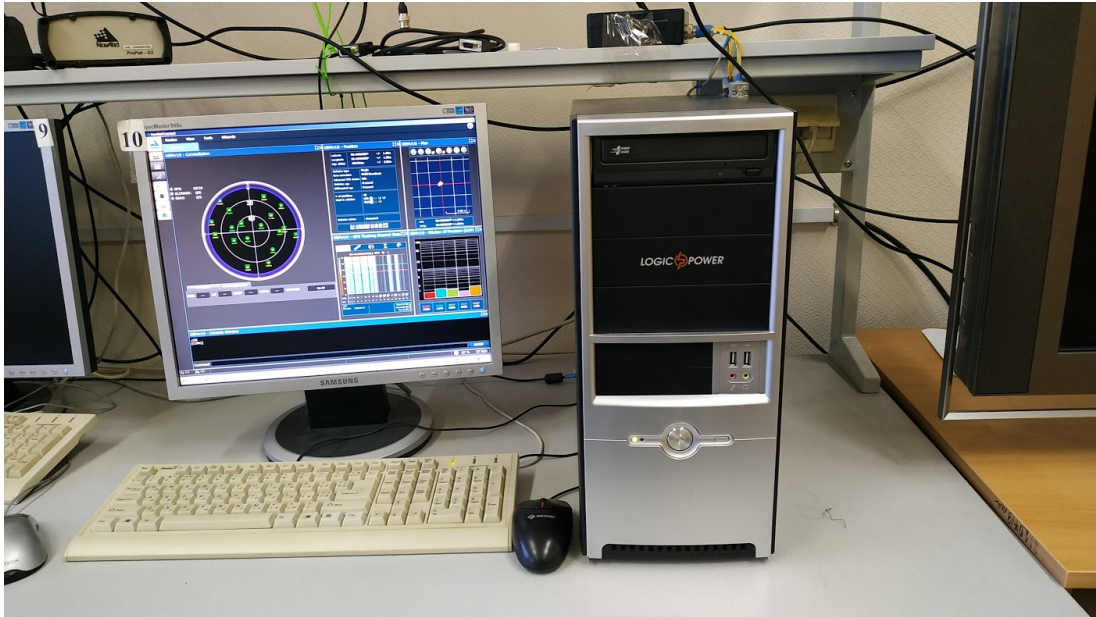

Figure 9. PC used in GNSS Simulation

3.9.1 GNSS antennas

GNSS Antenna is an application in GNSS Navigation and the main interface between the GNSS satellite constellations and GNSS receivers. They capture the L-band signals transmitted from space, which is the waveband used by many GNSS satellites constellations mentioned in 3.7.2 for broadcasting.

With new signals and frequencies coming on line with modernized GNSSs, antennas play a more crucial role in receiver system design. [42], there are different distinctive GNSS antennas depend on the envisage application;

- **Geodetic Antennas:** Survey and geodetic applications typically require fixed high-accuracy receivers and antennas, so it is common for multi-frequency / multi-constellation choke-ring antennas to be used for best performance.
- **Rover Antennas:** Rover antennas are typically used in land survey, forestry, construction, and other portable or mobile applications, hence they require a trade-off between accuracy and portability. Due to the need for mobility, the antenna is usually mounted on a handheld pole, stand or tripod. In general, due to size and weight constraints, choke ring antennas are not a good solution for rover applications, so higher phase center variations are often seen in rover antennas.

- **Handheld Receiver Antennas:** These antennas are found in most current smartphones and portable navigation devices, and the key design drivers are size, cost and power consumption constraints. Usually single-frequency antennas, they are available in a range of implementations such as helical or patch antennas, both passive and active. [43]

3.9.1.1 Antenna Power

In general, GNSS antennas do not need any electrical power to operate, and are referred to as passive antennas. Typical scenarios for passive antennas are mobile devices, where power consumption is a critical issue. However, passive antennas must connect to the receiver's front end with very low losses, since there is no amplification mechanism involved at signal reception.

In applications in which the antenna can be away from the receiver (e.g. rooftop antennas), as this as the same case of the used antenna in this Master's work, the amplification of the signals can be implemented in the antenna itself, and for that fact they are called active antennas. Their purpose is to amplify the received signal to compensate for potential losses in long coaxial cables, at the cost of higher power consumption (power is usually delivered from the front end through the coaxial cable itself [43] the used Antenna in this project is shown below in figure 10.



Figure 10. GNSS Antenna

3.9.2 The GNSS Signal Splitter

The GNSS Signal Splitter is a signal splitter that is used to distribute GNSS signals to several Repeaters with minimal signal loss. The signal splitters operate over a frequency that allow the GNSS, Inmarsat, DC power is passed from -4 dB port to antenna port connected to GNSS receiving outdoor antenna. [44] Below in diagram 1 showing how the signals pass through the splitter and continue to receiver.

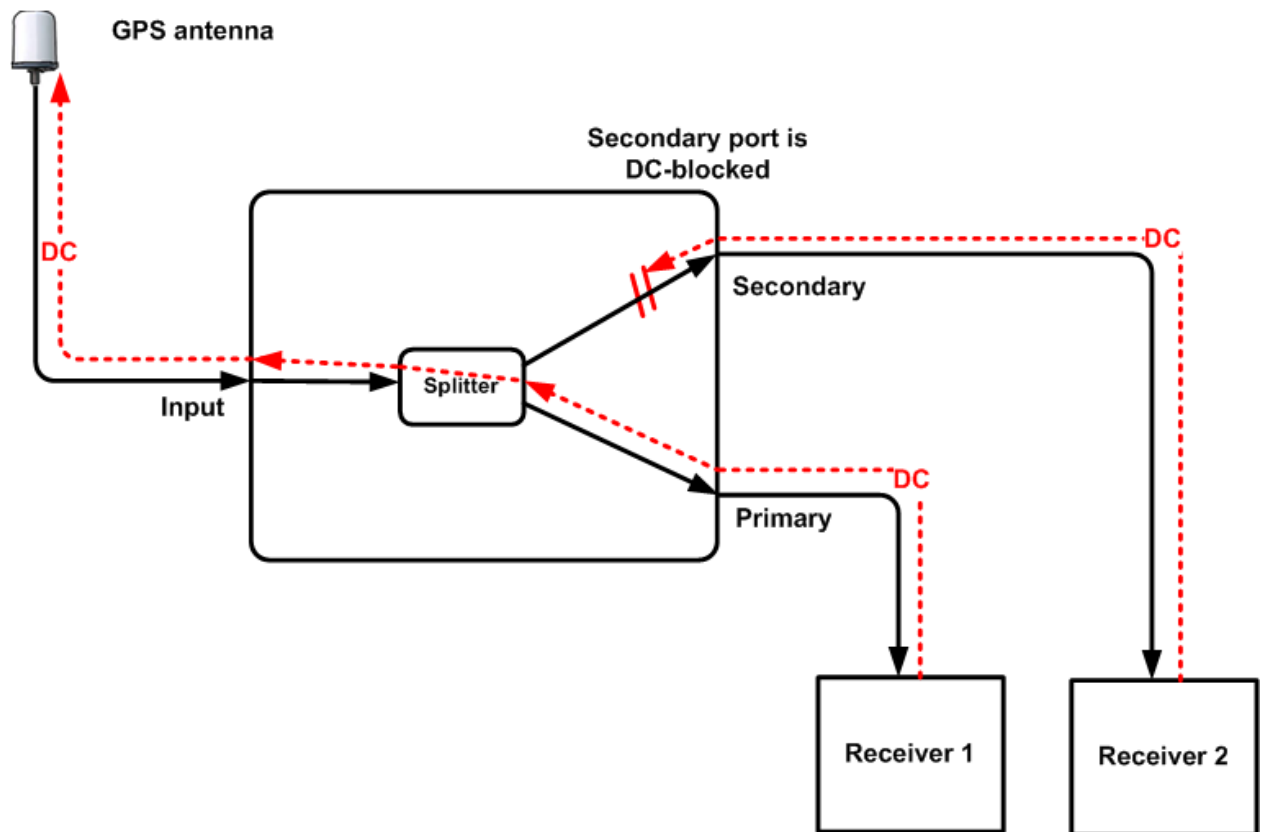

Diagram 1. Splitter [45]

GNSS signal splitter used in this Master's work is shown in figure 11. It was used to split active and passive GPS antenna's RF-signal to several GPS receivers. It can be traditional GPS receiver but also communication system to other satellites.



Figure 11. GNSS splitter

3.9.3 GNSS Receiver

GNSS Receiver is the key element of GNSS equipment, it carrier waves transmit information from the satellite to the earth by recording position, velocity and time information to be used by the application.

It processes the Signals In Space (SIS) transmitted by the satellites, being the user interface to any Global Navigation Satellite System (GNSS). Even though the information provided by a generic GNSS receiver can be used by a wide range of Applications, most of them rely on the receiver's navigation solution [46] In their most common architecture, GNSS receivers assign a dedicated channel to each signal being tracked and, for the case of multi-frequency receivers, each signal from each satellite can be processed independently. In order to ensure tracking of the signals in each processing channel, receivers are continuously estimating and correcting two parameters:

- **The code delay:** quantifies the misalignment between the local PRN code replica and the incoming signal.
- **The carrier phase** (or its instantaneous value, the Doppler frequency): reflects the relative motion between the satellite and the user.[46]

In this Paper, two types of receivers were used:

- Novatel ProPak LB plus: combines accuracy and affordability as a GPS+ receiver featuring integrated access to OmniSTAR's High-Performance (HP) satellite technology. The used Novatel ProPak LB plus is shown on the figure 12

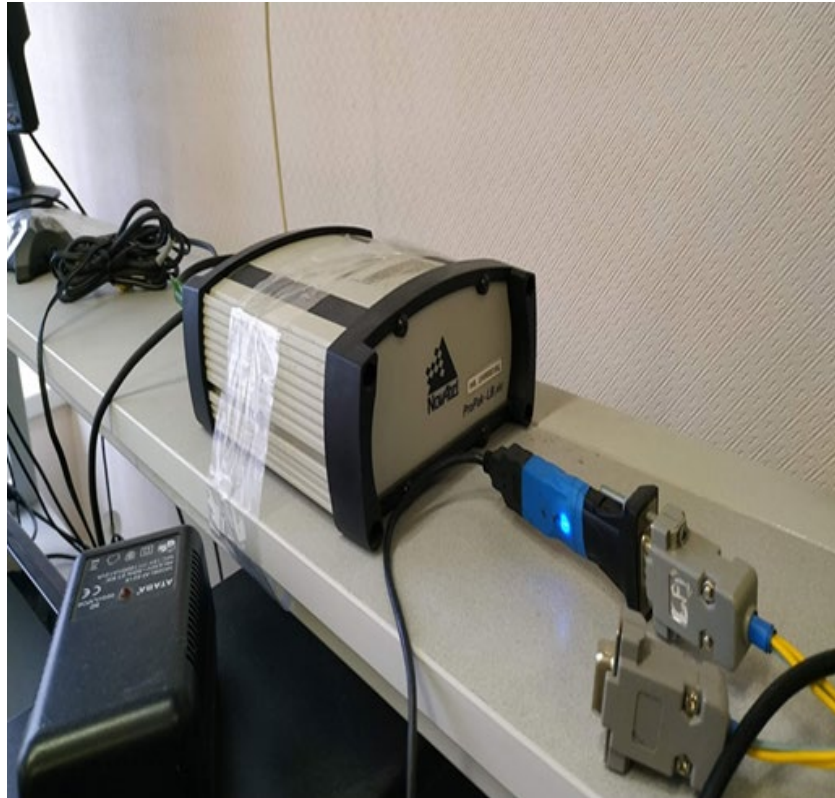

Figure 12. Novatel ProPak LB plus

- Novatel ProPak G2: is a durable, triple-frequency GNSS receiver that tracks GPS + GLONASS as well as L-Band and SBAS. There are some benefits of using this receiver such as: Multi-constellation tracking yields higher solution availability and reliability, Durable metal enclosure ensures reliable positioning in harsh environments and EMI conditions etc..

Figure 13, present Novatel ProPak G2 used in this paper

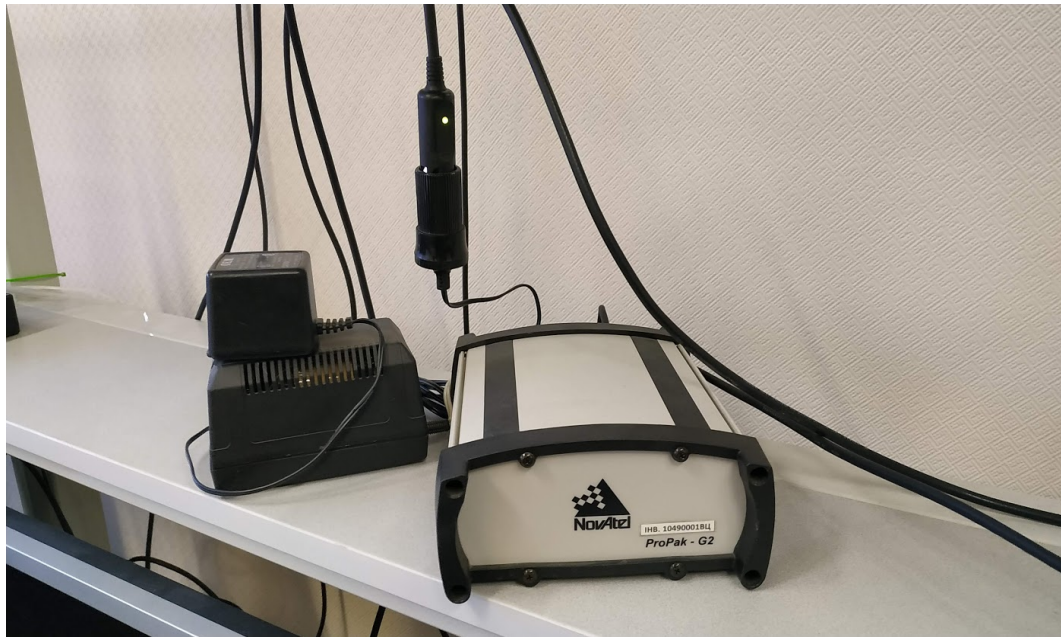

Figure 13. Receiver Novatel ProPak G2

3.9.4 Component Software

Software component is designed to work as a larger application. A good analogy is the way personal computers are built up from a collection of standard components: memory chips, CPUs, buses, keyboards, mice, disk drives, monitors, etc. Because all of the interfaces between components are standardized, it is possible to mix components from different manufacturers in a single system. With that being said, in this study, MATLAB software is used to interpret, analyses the received data from the GNSS receiver having the Satellite Navigation (SatNav) toolbox as a facilitator of this process. It also helps to process real data with RINEX support, as well as satellite constellation analysis (both broadcast ephemeris and almanac).

The toolbox is delivered as a set of MATLAB Code files. The SatNav Toolbox is fully compatible with the GPSofT Inertial Navigation System (INS) Toolbox, which allows for simulation of integrated GPS and INS applications. GPSofT also offers hands-on training courses using the SatNav Toolbox to provide engineering professionals with practical experience in simulating and analyzing global navigation satellite systems. [50]

```

clear all
Start = cputime;
%1.07.2018 ВНИМАНИЕ При использовании файла с расширением "BIN",
полученного
%с помощью NovAtel Convert необходимо в функциях Read_Best и Read_RAIM2
% разблокировать строку oA = fread(fid,1,'uchar');
%Dat_In_GPS= 'In_date5\OEM719_13-12-2018_11-02-57.BIN'; %поставить oA
Dat_In_GPS= 'bestpos_raitm_25_10.gps';
fid = fopen(Dat_In_GPS,'rb');
% fw = fopen('Out_GPS_Dat\2015_02_19_GPS.txt','wt');
%%%%%%%%%%%%%%%%%%%%%%%%%%%%%%%%%%%%%%%%%%%%%%%%%%%%%%%%%%%%%%%%%%%%%%%%
nameFigure =
'd:\MatLab_Programs\2017_RAIM_BEST_dipl\FigGLGALBDSQZSS\bestpos_raitm_25_10.
gps';%FigGLGALBDSQZSS
% filename1 = 'FigD\2018_10_12RMG1GalBDS QZ1';
% filename2 = 'FigD\2018_10_12RMG1GalBDS QZ2';
% filename3 = 'FigD\2018_10_12RMG1GalBDS QZ3';
% filename4 = 'FigD\2018_10_12RMG1GalBDS QZ4';
% filename5 = 'FigD\2018_10_12RMG1GalBDS QZ5';
% filename6 = 'FigD\2018_10_12RMG1GalBDS QZ6';
% filename7 = 'FigD\2018_10_12RMG1GalBDS QZ7';
filename1 = strcat(nameFigure,'1');
filename2 = strcat(nameFigure,'2');
filename3 = strcat(nameFigure,'3');
filename4 = strcat(nameFigure,'4');
filename5 = strcat(nameFigure,'5');
filename6 = strcat(nameFigure,'6');
filename7 = strcat(nameFigure,'7');
filename8 = strcat(nameFigure,'8');
filename9 = strcat(nameFigure,'9');
%%%%%%%%%%%%%%%%%%%%%%%%%%%%%%%%%%%%%%%%%%%%%%%%%%%%%%%%%%%%%%%%%%%%%%%%555
i = 0;
i1 = 0;
i2 = 0;
% for i = 1: 100
%for i = 1 : 28000
while (~feof(fid)) i = i + 1;
    Syn_c = fread(fid,3,'uchar') ; %B OEM-4 'Char'
    Hear_d= fread(fid,1,'uchar') ; %B OEM-4 'Uchar'
    Message_ID = fread(fid,1,'uint16') ; %B OEM-4 'Long'
    % fprintf('Message_ID =%i \n ',Message_ID);

    if Message_ID== 1286
        i1 = i1 + 1;
        [HPL(i1) VPL(i1) Time( i1)] = Read_RAIM2(fid);

    end

    if Message_ID== 42
        i2 =i2 + 1;
        [Lat(i2) Lon(i2) h(i2) Lat_sigma(i2) Lon_sigma(i2) h_sigma(i2)
TimeGPS(i2)] =...
        Read_Best(fid);

    end
end
end
% TimeGPS = TimeGPS(1:2:i2);
% plot(h), grid minor
% plot(VPL), grid minor

```

Gsigma = sqrt(Lat_sigma.^2+Lon_sigma.^2);% Прогноз приемника

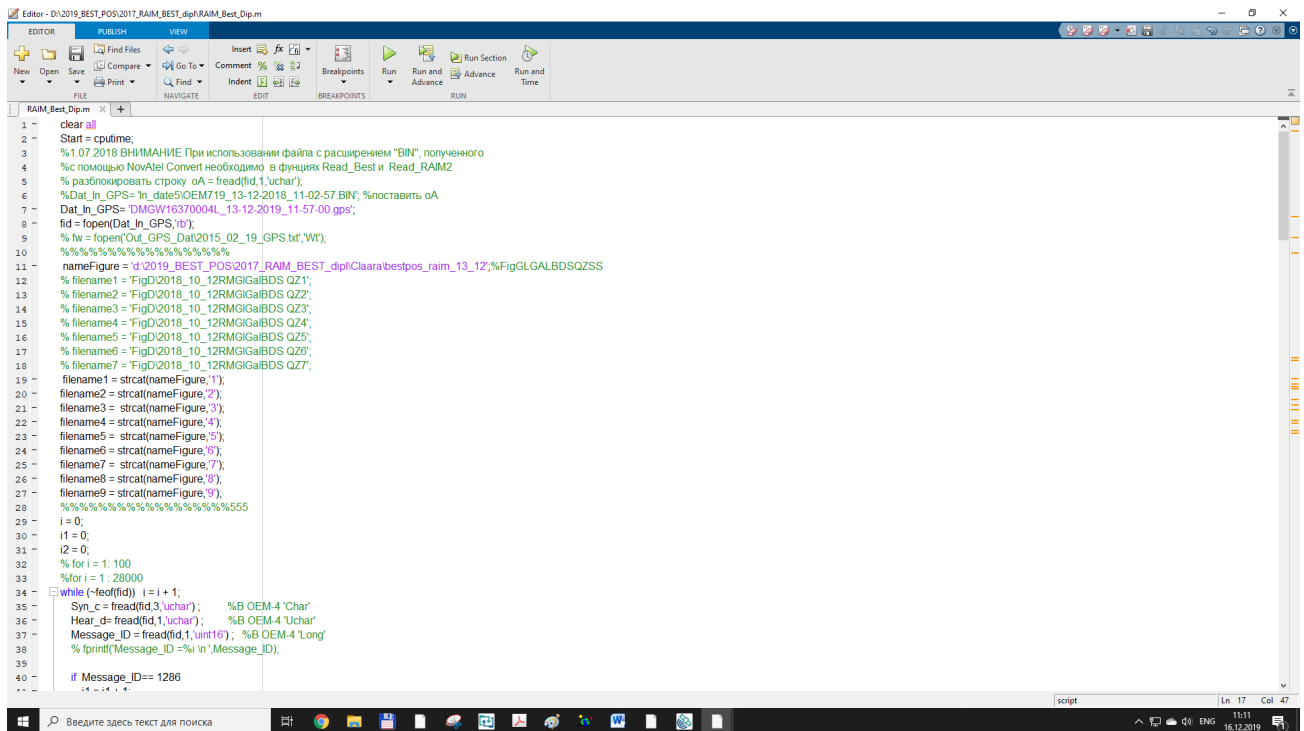

Figure 14. MATLAB (more in Appendix B)

3.9.4 Model visualization.

The results of calculations are presented in graphs and charts. Their creation and filling of information is a function of the model visualization, which is a specially created scenarios that can be triggered and executed by a PC. The graphs that are used in this paper are named Stanford diagrams as commonly said, it came from a laboratory of Stanford University, after the well-known proposed Integrity-Availability-Accuracy 2D histogram.

3.9.4.1 Stanford Diagram/Plots

The so-called Stanford diagram (or Stanford plot) has been introduced in and presents a valuable tool for monitoring and assessing positioning system performance and protection in terms of availability and integrity.

The layout of a generic Stanford diagram is shown in figure 15. For each sample position and protection level, a point is plotted in the Stanford diagram whose abscissa presents the absolute position error and whose ordinate represents its associated protection level, Usually, separate

Stanford plots are represented for the Horizontal Position Error (HPE) and Vertical Position Error (VPE), corresponding to HPLs and VPLs, respectively. The diagonal axis separates those samples in which the position error is covered by the protection level, above the diagonal, from those, below the diagonal, in which the protection level, fails to cover the position error. Stanford plots allow an easy and quick check that integrity holds, just by making sure that all sample points lie on the upper side of the diagonal axis. Also the proximity of the cloud of sample point to the diagonal gives an idea of the achieved level of safety, as any point above the diagonal but very close to its indicates that an integrity event was close to occur.

The Stanford diagram actually accounts for integrity events (not for integrity failure) and allows to distinguish between two types of integrity events:

- Misleading Information (MI) events, and
- Hazardous Misleading Information (HMI) events.

A MI event occurs when, being the system declared available, the position error exceeds the protection level but not the AL. A HMI event occurs when, being the system declared available, the position error exceeds the AL.

The concept of the Stanford diagram has been further improved in [48] and the Stanford diagram position error has been shown in diagram 2;

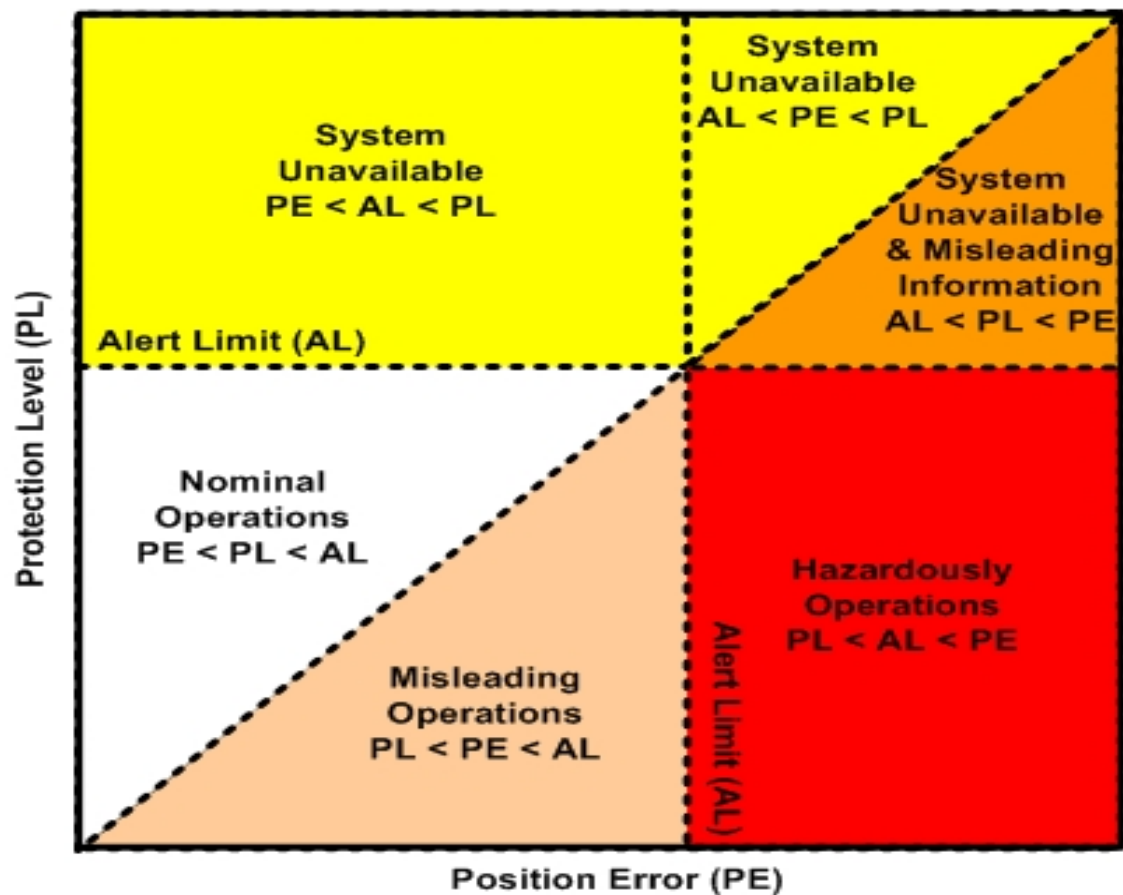

Diagram 2. Stanford Diagram [49]

- For each combination of satellites, compute the HPE, HPL, pair and the VPE, VPL pair
- Include in a Stanford diagram the (HPE, HPL) pair or the (VPE, VPL) pair, respectively leading to a graph with horizontal or vertical information about the minimum so-called Safety Index.

Taking vertical plot as an example, the relationship between integrity and PL/AL/PE is given as follows;

- When $PE < AL < PL$ the system is unavailable, $AL < PL$ indicates that the system is unavailable and meanwhile $PE < PL$ indicates that position errors meet the limit of protection levels
- When $PE < PL < AL$, the system is available, $PL < AL$ indicates that the system is available, based on this $PE < PL$ indicates that position errors meet the limit of protection levels.

- When $PL < PE < AL$ or $AL < PL < PE$, the system may give Misleading Information (MI). and when $PL < AL < PE$, the system gives Hazardously Misleading Information (HMI) [57]

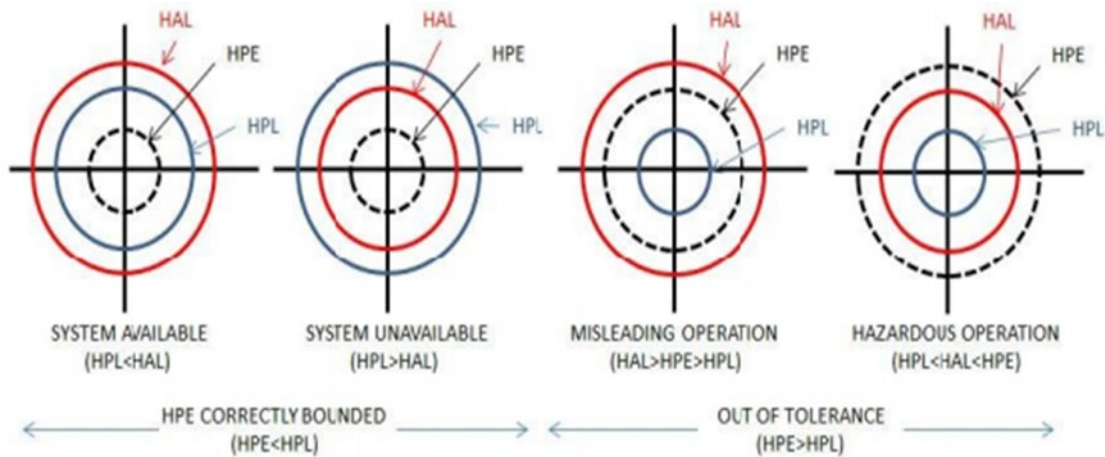

Figure 15. Possible situations obtained with GNSS integrity monitoring [53]

Therefore, through the relationship above, we can monitor and assess integrity of the navigation system clearly by Stanford Plot.

3.9.5 Scheme diagram of Simulation Process

In brief, Diagram 3 present the general view process of simulation task of this Master's work;

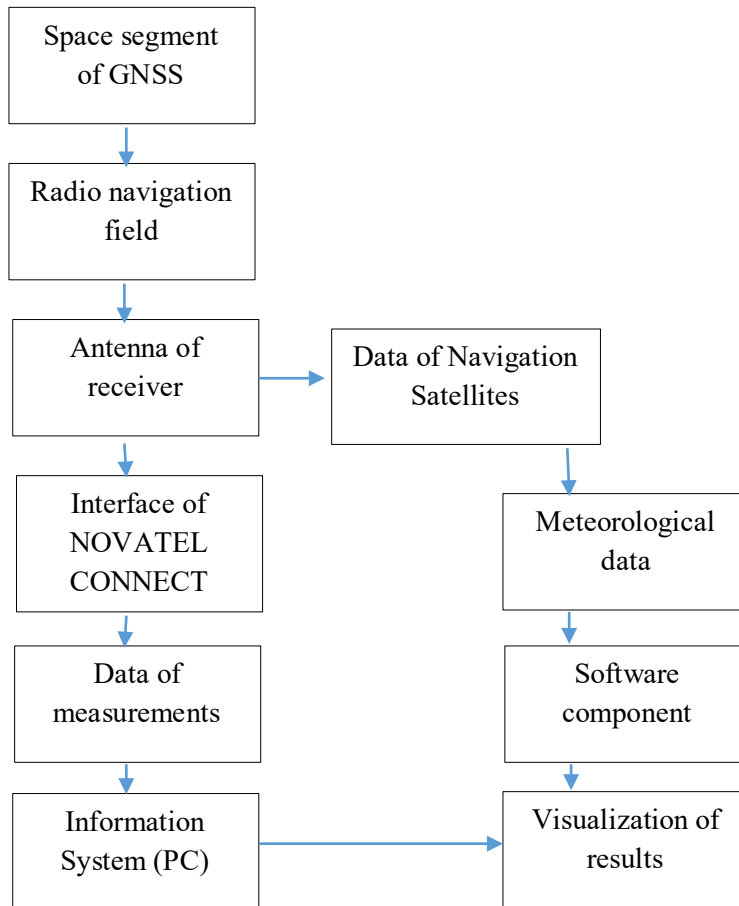

Diagram 3. GNSS simulation Process

CHAPTER 4

Results and Analysis

This chapter presents the results of this Master's work, Stanford plots are used to present the outcome of the simulation showing the performance of GNSS with two constellations GPS and Galileo Navigation System for final approach of Aircraft.

For the functionality and validation purpose, it has been shown in the following by the use of Stanford diagram taking weather (Atmospheric weather) into account that the use of combined satellites provides a concrete and reliable guidance at the final approach when comparing with the single satellite.

4.1 GPS simulation

All the results presented in this section are based on the simulation settings listed below;

- Simulation Date: 18/12/19
- Orbit parameters: 7 visible GPS satellites
- Range accuracy: Mode 2, 6 meters
- Atmospheric errors: 6 meters, GDOP < 6
- Total Pseudo-range measurement errors: 6 meters
- Message Position: BestPos and Raimstatus
- Format: Binary
- Mask Angle: 20

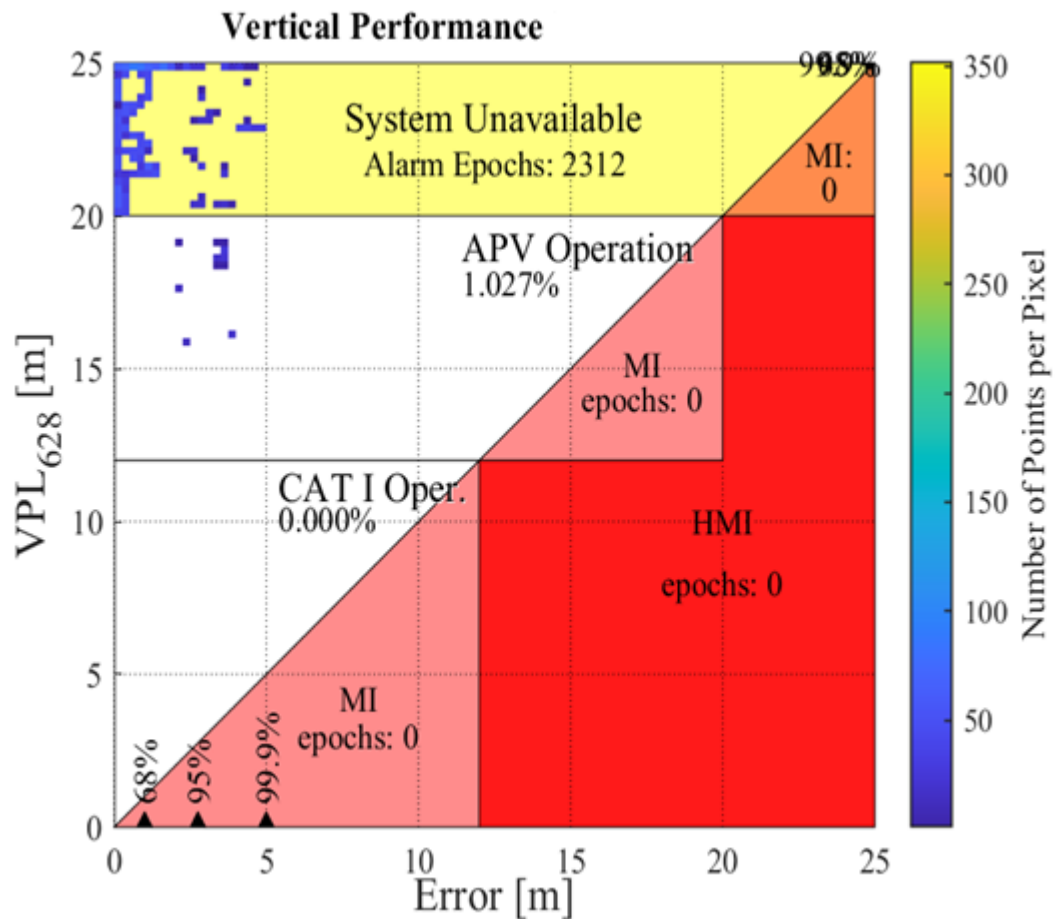

Diagram 4. Stanford Plot for the Vertical Performance

Stanford Plot for the Vertical Performance. The horizontal axis is the Vertical Position Error (VPE) and the vertical axis the Vertical Protection Level (VPL). The Alert Limit is also shown in the plot as horizontal and vertical lines at 20m. Each bin indicates (in a logarithmic color scale) the number of occurrences of a specific (VPE, VPL) pair, it is also indicated that, there is no chance of normal operation at the vertical performance and the system is unavailable.

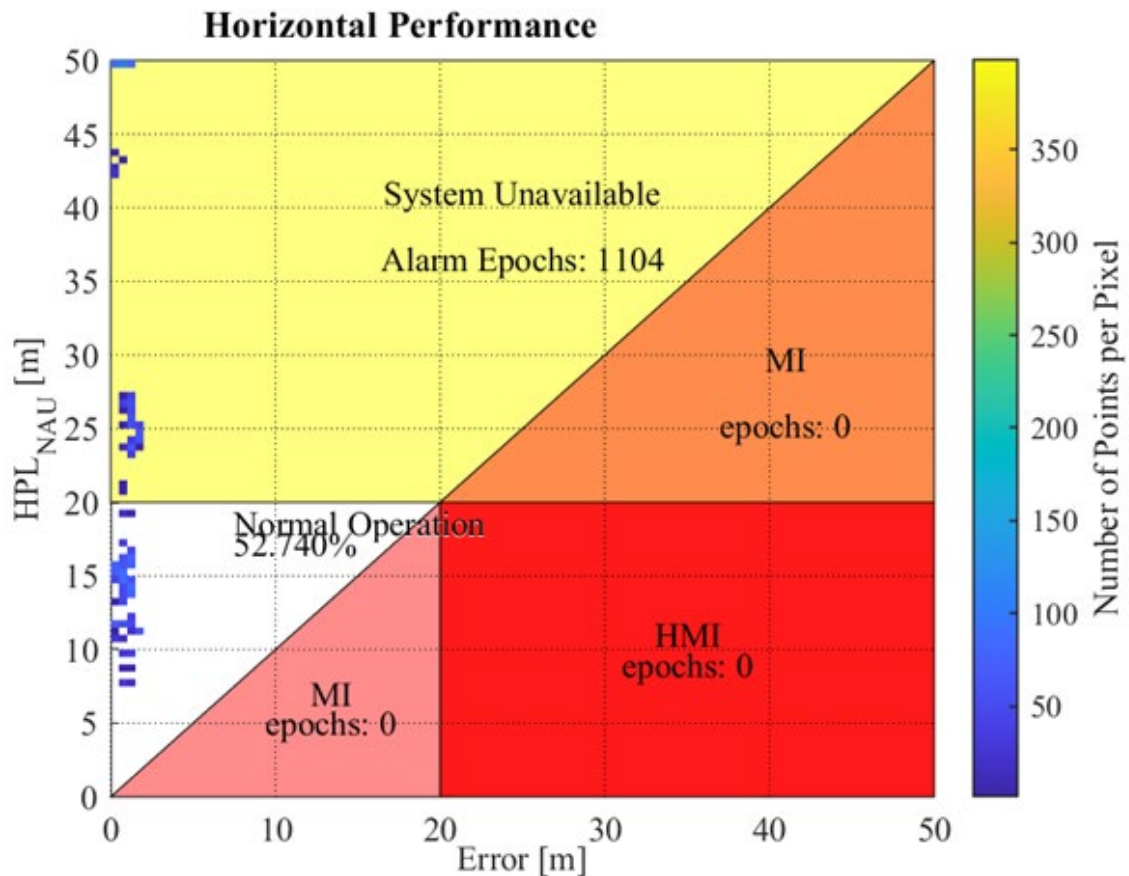

Diagram 5. Stanford Plot for the Horizontal Performance

Stanford Plot for the Horizontal Performance. The horizontal axis is the Vertical Position Error (VPE) and the vertical axis the Horizontal Protection Level (HPL). The Alert Limit is also shown in the plot as horizontal and vertical lines at 20m. it is also indicated that the normal operation is available with 52%.

4.1.1 VP and HP Analysis

Standard APV I (HAL=20m, VAL=20m) The results of the experiment are shown in diagram 2 and table 5 contains the percent of epochs. Normally in the long-time experiment, numbers of epochs are zero when the system is unavailable or the system gives HMI. Thus the percentage of MI for both sides VAL and HAL is 0%, In this case the system can provide a risk service of 1% in the VAL and 53 % in horizontal.

Therefore, the integrity of GPS alone is not good of use, it is advised to improve it for better navigation at the final approach.

Table 6. Numerical Analysis of VP and HP

	<i>Integrity Performance</i>	
	VP	HP
<i>MI</i>	0	0
<i>HMI</i>	0	0
<i>System Unavailable</i>	99%	41%
<i>System Available</i>	1%	53%
<i>Alarm Epoch</i>	2312	1104

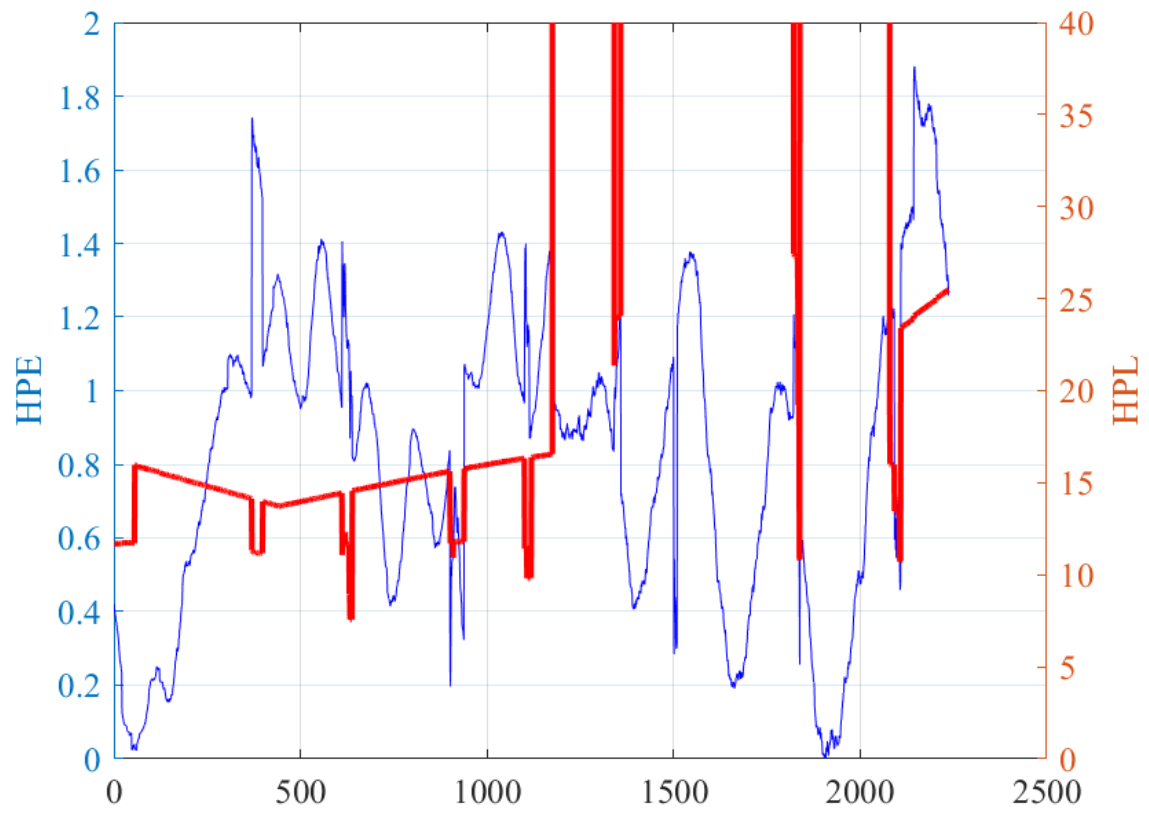

Figure 16. Plot of HPE/HPL

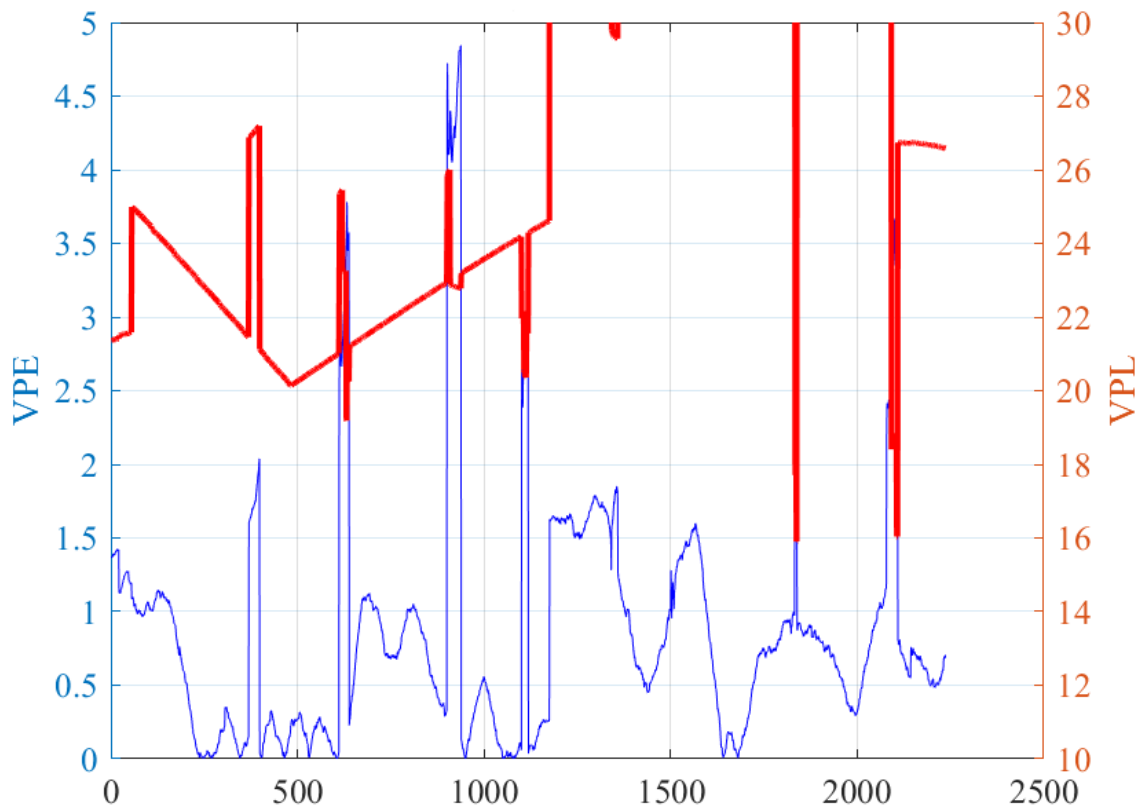

Figure 17. Plot of VPE/VPL

The first conclusion that may be drawn from figure 16 and 17, is that HPE was slightly close to 2m with 1.85 meters and VPE with 4.8 meters which were higher than the standard of a good performance. 40 m for HPL and 30 meter for VPL. The second, from the graphics there is a low chance of performing CAT-I since HPL exceeds the corresponding HAL which marks the system unavailable.

4.2 GPS and Galileo simulation

All the results presented in this section are based on the simulation setting listed below;

- Simulation Date: 16/01/2020
- Orbit parameters: 8 visible GPS satellites and 6 Galileo satellites
- Range accuracy: Mode 2, 6meters
- Atmospheric errors: 6, GDOP<6
- Total Pseudo-range measurement errors: 6 meters
- Message Position: BestPos and Raimstatus
- Formal: Binary
- Mask Angle : 20

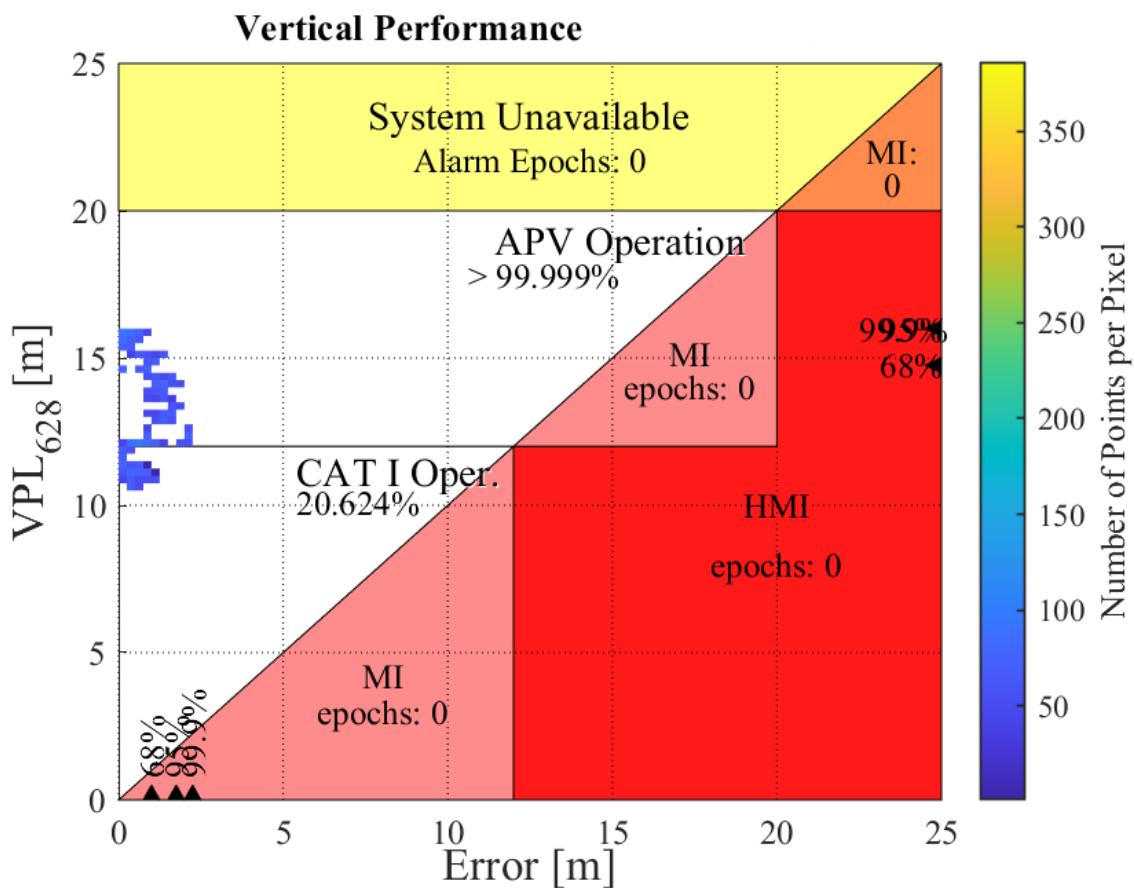

Diagram 6. Vertical Performance of GPS + Galileo

Stanford Plot for the Vertical Performance of a combined constellation GPS and Galileo is presented above. The horizontal axis is the Vertical Position Error (VPE) and the vertical axis

the Vertical Protection Level (VPL). The Alert Limit is also shown in the plot as horizontal and vertical lines at 20m. Each bin indicates (in a logarithmic color scale) the number of occurrences of a specific (VPE, VPL) pair, it is also indicated that, there is a high probability $>99.999\%$ of normal approach regardless of weather interferences, and CAT-I can also be carry on at the vertical performance and the system is available.

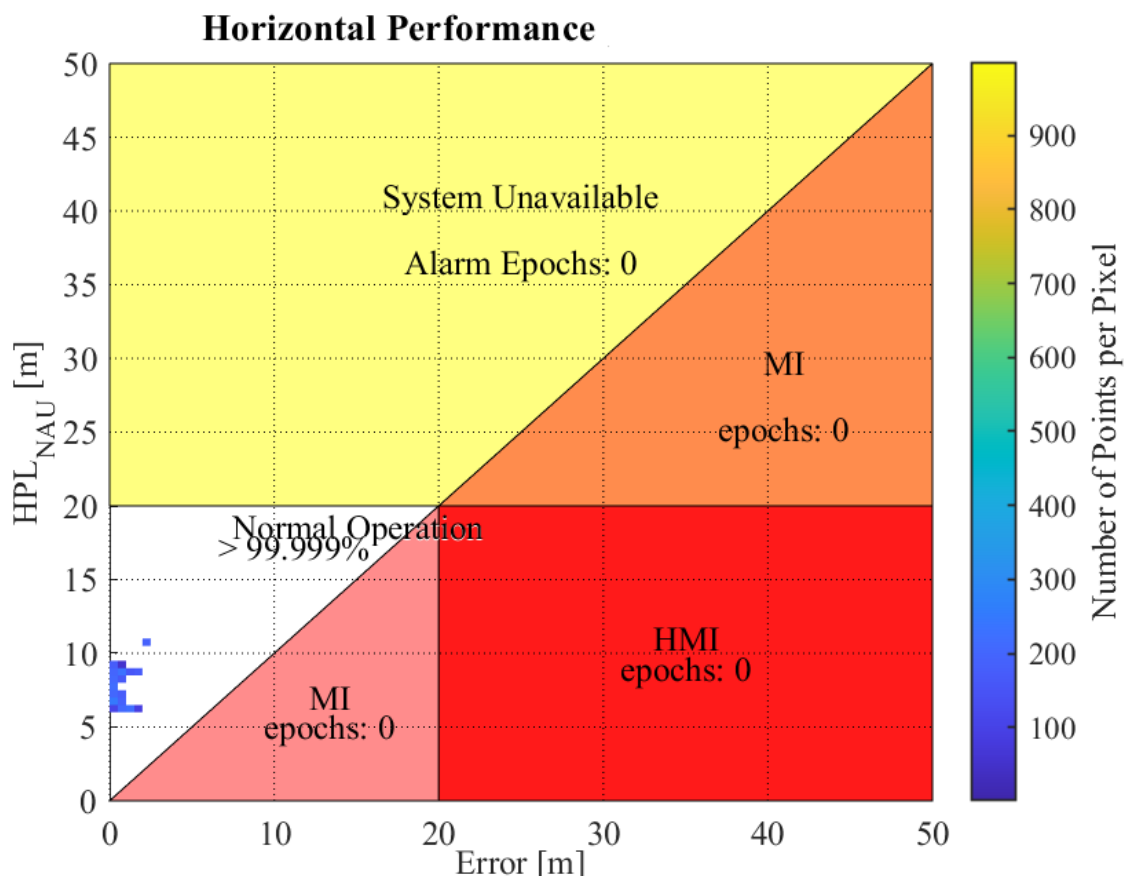

Diagram 7. Horizontal Performance of GPS + Galileo

Stanford Plot for the Horizontal Performance of a combined constellation GPS and Galileo is shown on the figure above. The horizontal axis is the Vertical Position Error (VPE) and the vertical axis the Horizontal Protection Level (HPL). The Alert Limit is shown in the plot as horizontal and vertical lines at 20m. it is clear that the normal operation for Horizontal performance is available with a high probability of $>99.999\%$, thus the system is available

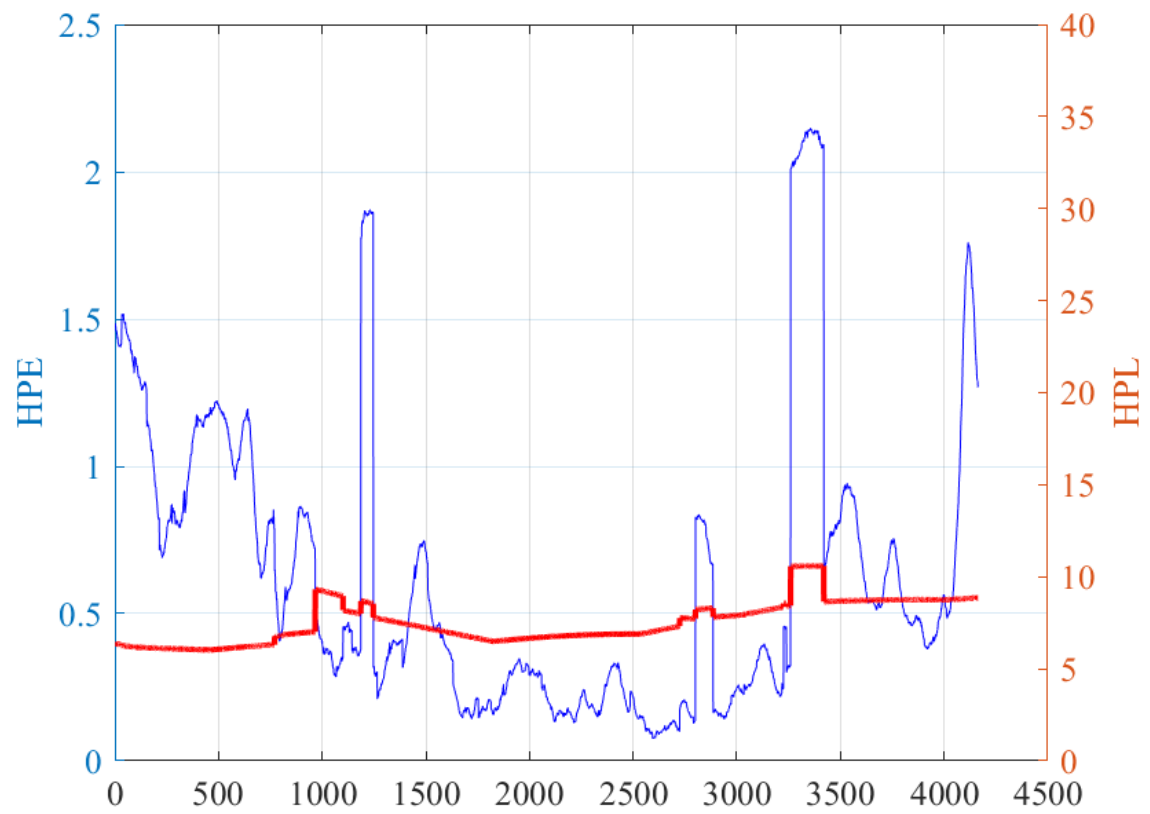

Figure 18. HPE/HPL of GPS + Galileo

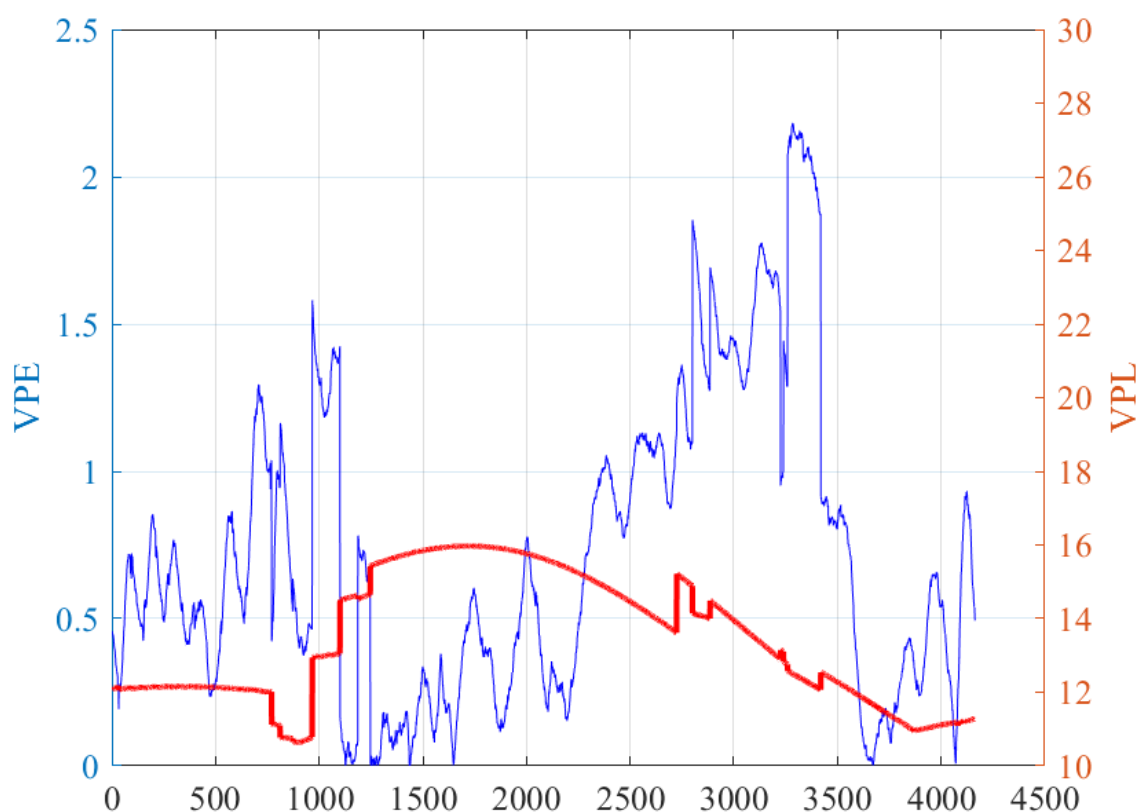

Figure 19. VPE/VPL of GPS + Galileo

The first conclusion that may be drawn from figure 6-7, is that both HPE and VPE were 2.2m and 9 meters for HPL and 11 meters for VPL. It is also observed from the graphics that there is a high chance of performing a safe navigation since CAT-I Availability is experienced, as the VPL only exceeds the VAL during a short period of time and the HPL never exceeds the corresponding HAL.

Therefore, It is well seen that GNSS multi constellation of GPS and Galileo can improve Air Navigation in the bad weather condition, all the mentioned results above were simulated on different days, considering the impact of atmospheric layers mentioned in this study as interference of the signals, based on the outcome of the results, the combination of two satellite will improve the signals perturbation. With that being said, Pilot will be sure that the enough information of NavAids has been provided for final approach and all this will solve the problem of missing approach or go around procedure due to bad weather conditions.

4.3 Innovative Algorithm

A presentation of developed algorithm for better approach using the signals received from a combination of constellations GPS and Galileo is shown below.

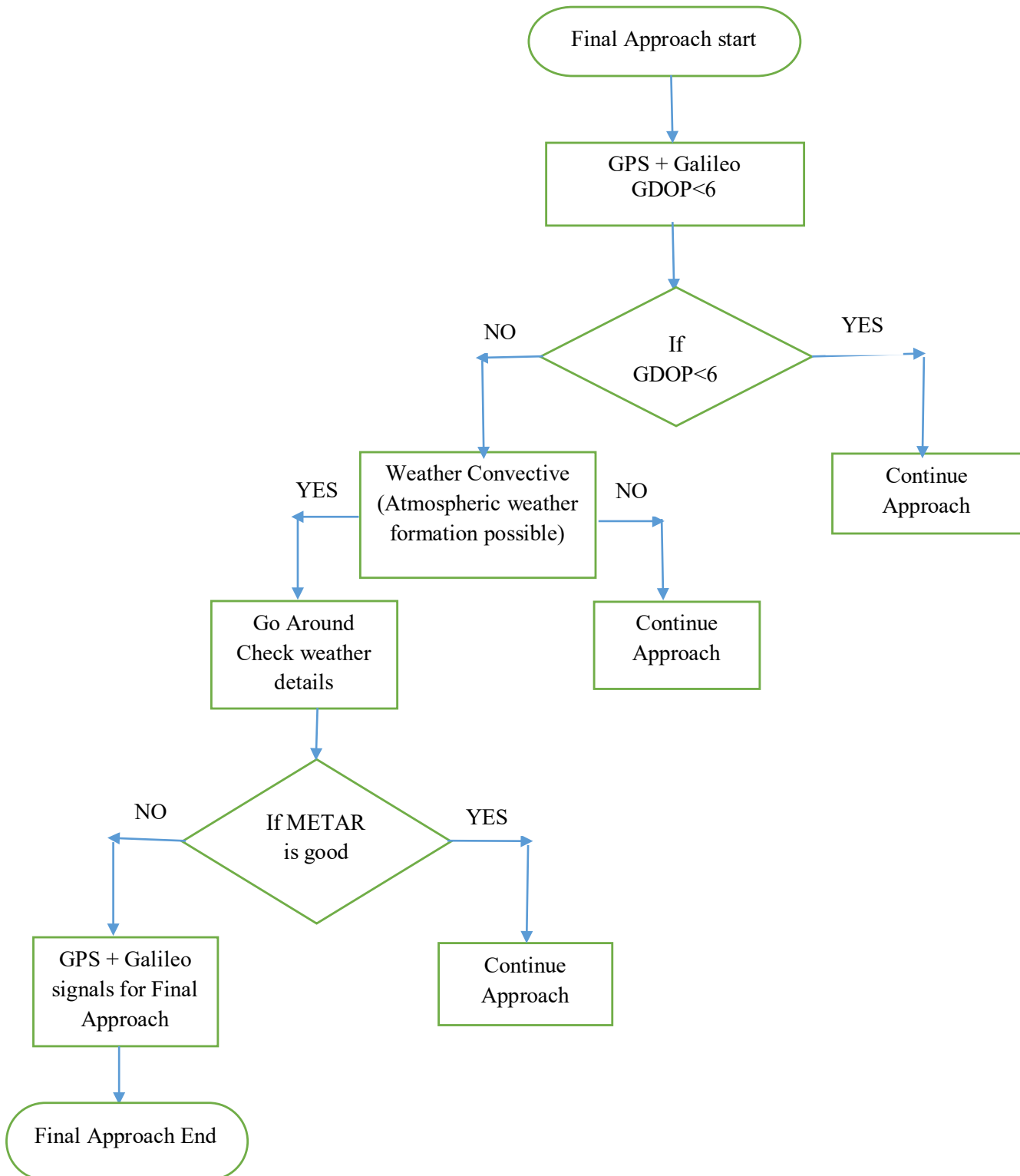

Diagram 8. Developed innovative Algorithm

CHAPTER 5

Conclusion and Recommendation

This chapter presents the conclusions from the results obtained in the previous chapters and draws some perspectives for future work.

5.1 Conclusion

In this Masters work, key issues of atmospheric weather to GNSS performance were investigated to define the optimal way to assist on the final approach of an aircraft. Indeed, issues of weather mostly Troposphere layer and Ionosphere were examined at 3.8 of this study. One of the goal of this Masters work was to check the available integrity status of the visible satellites in the bad weather conditions as a matter of fact the possibility of getting enough signals for better navigation were obtained. Also, in order to meet the most stringent requirements of CAT-I precision approach operations, key issues must be solved relating to atmospheric modelling, thus this Masters contain some specific analysis to the troposphere and Ionosphere modelling and the protected level to express the GNSS positioning error.

Previous work done by different authors to assess the anomalous troposphere and Ionosphere impacts on GNSS signals were under-sampling the possible geometries and the proposed methodology appeared conservative, some taking message format of GPS GBAS or SBAS, however having the alternative way of navigation were needed, that is why in this Masters study, the possibility of providing additional data to the aircraft for a safe approach was made especial for CAT-I operations.

Therefore, by keeping in mind that low data transmission of signals is required and by comparing the performance of GNSS from other constellations 3.7.1, we should note that GPS plus Galileo are the best possible constellations as shown in the previous chapter whereby, GPS alone couldn't perform better than GPS and Galileo together, where the combined constellations give a 99.9% operation of CAT-I in bad weather. And through this approach, in

order to protect the user against the misleading of the signals or absence of them due to troposphere and ionosphere interferences, a combined receiver device must be installed in the aircraft to receive the signals from multi constellation GPS and Galileo, especially in the bad weather condition instead of using one constellation receiver. Furthermore, the objectives of this study were successfully achieved whereby the necessary analysis was made in this study to identify the effects and impact of atmospheric weather to GNSS signal performance, the integrity monitoring in the less visible satellites were calculated and lastly the developed innovative algorithm was presented to highlight the efficiency and importance of multi-constellation GPS/Galileo as an additional navigation aid to Final Approaches.

5.2 Recommendations

In the scope of generating a safety procedure for Air Navigation, more simulations should be processed using other constellations considering the weather interferences and the mentioned algorithm should be improved by adding extra satellites. For instance, Beidou. Therefore, a single index could be sent to aircraft to select the best way by considering the appropriate levels for all regions

A validation step solution should be conducted to validate the use of two constellations developed in this study for finding the worst case horizontal or vertical range tropospheric and ionospheric delays.

Further Analysis should be done to propose the best navigation aids for a safer landing, and better navigation in different regions. Pilot should be aware of the new technology and all available source for safety issues, last but not least, as the integrity were exercise in this thesis, accuracy of GPS and Galileo should be conducted in the future work.

REFERENCES

- [1] Optimal GPS/Galileo, GBAS methodologies with an application to troposphere. Institute of National Polytechnique de Toulouse (INP Toulouse)
- [2] Mathematical Methods Applied to the Celestial Mechanics of Artificial Satellites, Volume 2012 |Article ID 734280 | 15 pages
- [3] ICAO International Standards and Recommended Practices, Annex 10 Convention on International Civil Aviation, Volume I, Radio Navigation Aids, sixth edition (including Amendment 85 dated July 12 2010, July 2006
- [4] Fly GLS, GBAS approach and landing systems, the future of precision approach,” [Online]. Available: <http://flygls.net/>.
- [5] ICAO, performance-based Navigation (PBN) Manual, Third Edition, 2008.
- [6] ICAO, International Standards and Recommended Practices, Annex 6 Convention on International Civil Aviation, Operation of aircraft, Eighth edition, Jul. 2001.
- [7] O.Julien, Advanced Concepts of GNSS-IENAC 3rd year, 2011/2012.
- [8] CICTT, phases of flight definitions and usage notes, Commercial Aviation Safety Team/International Civil Aviation Organization, Common Taxonomy Team, Feb. 2006.
- [9] Macabiau, Analysis of the Feasibility of Using GPS Carrier Phase Ambiguity Resolution Techniques for Precision Approaches, PhD thesis, Institute National Polytechnique de Toulouse, Sep. 1997.
- [10] ICAO, International Standards and Recommended Practices, Annex 6 Convention on International Civil Aviation, Operation of Aircraft, Eighth edition, Jul. 2001.

References

- [11] L.Montloin, impact of GNSS singular events on the integrity of airport navigation systems, Toulouse, 2014.
- [12] Jepperson ICAO DOC decision making, 2001
- [13] ICAO, Performance-Based Navigation (PBN) Manual, Third Edition, 2008.
- [14] P. Neri, PhD thesis: Use of GNSS signals and their augmentations for Civil Aviation Navigation during Approaches with Vertical Guidance and Precision Approaches.
- [15] Performance Based Navigation (PBN) Airspace http://code7700.com/airspace_pbn.htm
- [16] “Annex 10 Convention on International Civil Aviation, Aeronautical Telecommunications, Volume I Radio Navigation Aids”, ICAO, Sixth Edition, July 2006
- [17] Hexagon Calgary Campus <https://www.novatel.com/an-introduction-to-gnss/chapter-3-satellite-systems/>
- [18] Global Navigation Satellite Systems (GNSS)
<https://www.unoosa.org/oosa/en/ourwork/psa/gnss/gnss.html>
- [19] Satellite Navigation - GPS- How It Works
https://www.faa.gov/about/office_org/headquarters_offices/ato/service_units/techops/navservices/gnss/gps/howitworks/
- [20] US Air Force Department, “GPS.GOV,”2016. [Online]. Available:
<http://www.gps.gov/systems/gps/space/>.
- [21] Department of Defense USA, GPS NAVSTAR, GPS SPS PS, 2008.
- [22] <https://galileognss.eu/galileo-frequency-bands/>
- [23] https://gssc.esa.int/navipedia/index.php/GNSS_signal
- [24] Impact of GNSS singular events on the integrity of airport navigation systems
<https://tel.archives-ouvertes.fr/tel-01377380/document>
- [25] Integrity Performance Models for a Combined Galileo GPS Navigation system,
<https://www.researchgate.net/publication/228696653>

References

- [26] Minimum Operational Performance Standards for Global Positioning System (GPS) / Wide Area Augmentation System Airborne Equipment, DO-229D”, RTCA, SC-159, December 2006
- [27] GNSS receiver autonomous integrity monitoring (RAIM) algorithm based on robust estimation <https://www.sciencedirect.com/science/article/pii/S1674984716300167#bib5>
- [28] Yuanxi Yang, Jinlong Li, Aibing Wang, Junyi Xu, Haibo He, Ha irong Guo, et al. Preliminary assessment of the navigation satellite system Sci China Earth Sci, 57 (1) (2014), pp. 1-9, 10.1007/s11430-013-4769-0
- [29] N.L. Knight GNSS integrity monitoring for two satellite faults International Global Navigation Satellite Systems Society, IGSS Symposium, Qld, Australia 1-3 December (2009)
- [30] Y, Lee Investigation of extending receiver autonomous integrity monitoring (RAIM) to combined use of Galileo and modernized GPS ION GNSS 17th International Technical Meeting of the Satellite Division, 21-24 September, Long Beach, CA (2004)
- [31] A new improved RAIM method based on the optimally weighted average solution (OWAS) under the assumption of a single fault ION NTM, January, Monterey, CA (2006)
- [32] J. Blanch, A. Ene, T. Walter, P. Enge An optimized multiple hypothesis RAIM algorithm for vertical guidance ION GNSS 20th International Technical Meeting of the Satellite Division, 25-28 September, Fort Worth, TX (2007), pp. 2924-2937
- [33] M. Choi, J. Blanch Demonstrations of multi-constellation advanced RAIM for vertical using GPS and GLONASS signals
ION GNSS 24th International Technical Meeting of the Satellite Division, 19-23, September, Portland, QR (2011), PP. 3227-3234
- [34] S. Hewitson, J. Wang GNSS receiver autonomous integrity monitoring with a dynamic model J Nav, 60 (2) (2007), pp. 247-263
- [35] W. Baarda A testing procedure for use in geodetic networks Netherlands Geodetic Commission, New Series Kanaalweg: Rijkscommissie voor Geodesie (1968)

References

- [36] Layers of Earth's Atmosphere | UCAR Center for Science Education
- [37] Royal Observatory of Belgium GNSS Research Group
http://gnss.be/atmosphere_tutorial.php
- [38] Rev. Bras. Geof. vol.26 no.4 Sao Paulo Oct./Dec. 2008 Errors due to tropospheric and ionospheric effects on the geographic location of data collection platforms
- [39] GEOG 862 GPS and GNSS for Geospatial Professionals
<https://www.education.psu/geog862/node/1719>
- [40] Global Positioning System Dilution of Precision (DOPs) Dilution of Precision (DOPs) May 23, 2014 submitted to: Sir. Ali Murad Kisana Institute of Geology, University of the punjab https://academia.edu/10085578/Dilution_of_Precision
- [41] WADGPS Laboratory (Stanford University). "WAAS Precision Approach Metrics. Accuracy, Integrity, Continuity and Availability," october 1997
- [42] Inside GNSS, Global Navigation Satellite Systems Engineering, Policy and Design <https://insidegnss.com/gnss-antennas/>
- [43] <https://gssc.esa.int/navipedia/index.php/Antennas>
- [44] Roger-GPS Oy finnoonniitynkua 4 02270 Espoo <https://www.gps-repeating.com/products/splitters/gnss-s-ip67-splitter.html>
- [45] <https://www.gps-repeaters.com/solutions/gnss-signal-splitter/>
- [46] https://gssc.esa.int/navipedia/index.php/GNSS_Receivers_General_Introduction
- [48] the Stanford-ESA diagram
- [49] <https://gssc.esa.int/navipedia/index.php/Integrity>
- [50] https://www.mathworks.com/products/connectiobs/product_detail/satellite-navigation-satnav-toolbox.html
- [51] <https://luftfartstilsynet.no/globalassets/dokumeter/allmennfly/pbn-gnss-ga.pdf>

References

[52] Aeronautical Information Services Aeronautical Chart User's Guide Terminal Procedure Publications

https://www.faa.gov/air_traffic/flight_info/aeronav/digital_products/aero_guide/media/editions/cug-tpp-edition.pdf

[53] Workshop on GNSS Data Application to Low Latitude Ionospheric Research by HEGARTY Christopher 6 - 17 May 2013 <http://indico.ictp.it/event>.

[54] Using GNSS raw measurement on android devices, white paper, Copyright © European GNSS Agency, 2017,

[55] https://www.spirent.com/blogs/positioning/2011/april/2011-04-25_what_is_raim

[54] Sensing of the atmospheric variation using Low Cost GNSS Receiver

<https://iopscience.iop.org/article/pdf>

APPENDICES

Appendix A

Pseudo-range Generation

As it was mentioned in this study 3.8 there are two atmospheric layers that affecting the signals propagations, and both have different properties however there are other parameters degrading the positioning performance of GNSS system. Although the concept of the Pseudo-range is simple, its generation is anything but straightforward, as this measurement of distance is obtained through time measurements. GNSS receivers process the received signals to obtain the transmitted (t_R) and received time (t_T). The difference of both is the signal's time of travel from the satellite to the receiver (assuming no extra delays due to ionosphere, troposphere and other elements). The can be computed as: [53]

$$P_u^s(t) = c(t_R - t_T)$$

Equation 20. Pseudo-range measurement

Where:

c : Speed of light in vacuum

$t_R - t_T$: Difference of transmitter and receiver of signal position generation and PVT computation can be implemented through two different methods:

- common reception time (also known as measurement time(t_{meas}^R))
- common transmission time

In the following paragraphs, Pseudo-range generation is based on the common reception time method. Considering four satellites with the same TOW being transmitted by all the satellites at the same time epoch, due to different propagations ways, signals arrive at the receiver with different delay. The receiver then computes the time offset between the TOW and the current time at the epoch. This is known as the measurement time t_{meas}^R . As a result, the transmitted satellite times (provided in GNSS system time) at measurement time can be expressed as:

$$t_{Tsat_1} = t_{TOW}^{GNSS} + D_1$$

$$t_{Tsat_2} = t_{TOW}^{GNSS} + D_2$$

$$t_{Tsat_3} = t_{TOW}^{GNSS} + D_3$$

$$t_{Tsat_4} = t_{TOW}^{GNSS} + D_4$$

Equation 21. GNSS system time measurement

Where:

t_{TOW}^{GNSS} : transmitted TOW

D_i : delay between the TOW and the measurement time

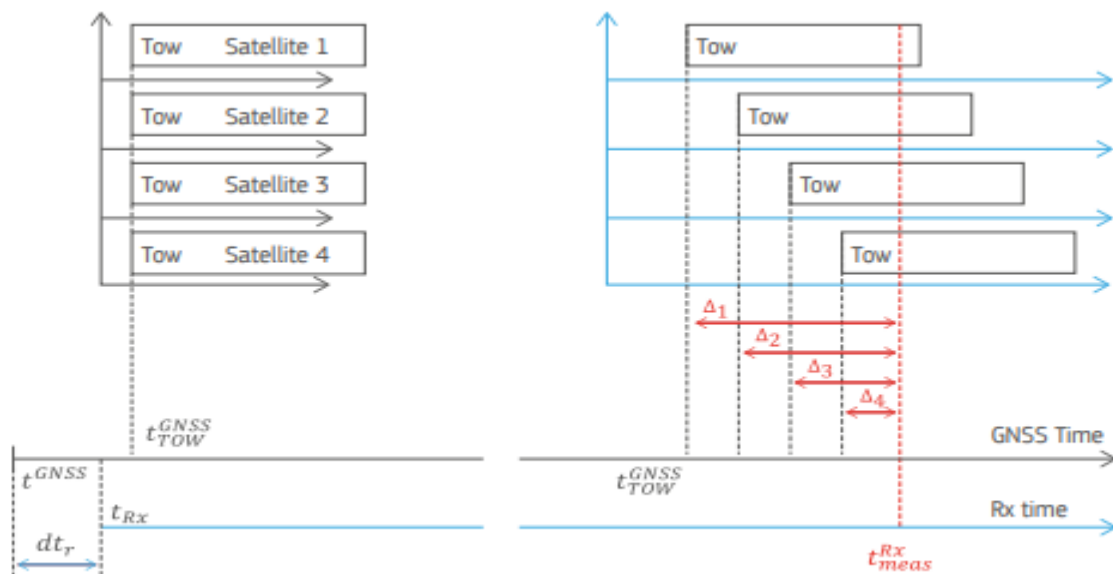

Figure 20. Demonstration of GNSS measuring time from transmitter to receiver

Before it computes the first PVT and decodes the TOW (Time of a week) from at least one satellite, the receiver has no information about the GNSS time. Thus, it must make assumptions in order to generate the Rx time and to compute the first set of pseudo-ranges. The first satellite signal to arrive is used as a reference. The received time is the transmitted time plus a reference propagation time (t_{Ref}^{path}). A standard value between 65 and 85 ms is usually assumed. Therefore, the first measured time can be computed as

$$t_{meas}^R[1] = t_{t\,sat_1}[1] + t_{Ref}^{path}$$

Equation 22. Measurement time

All other pseudo-ranges are generated relative to this. As constant error to all the satellites is present since t_{Ref}^{path} has been fixed, not estimated.

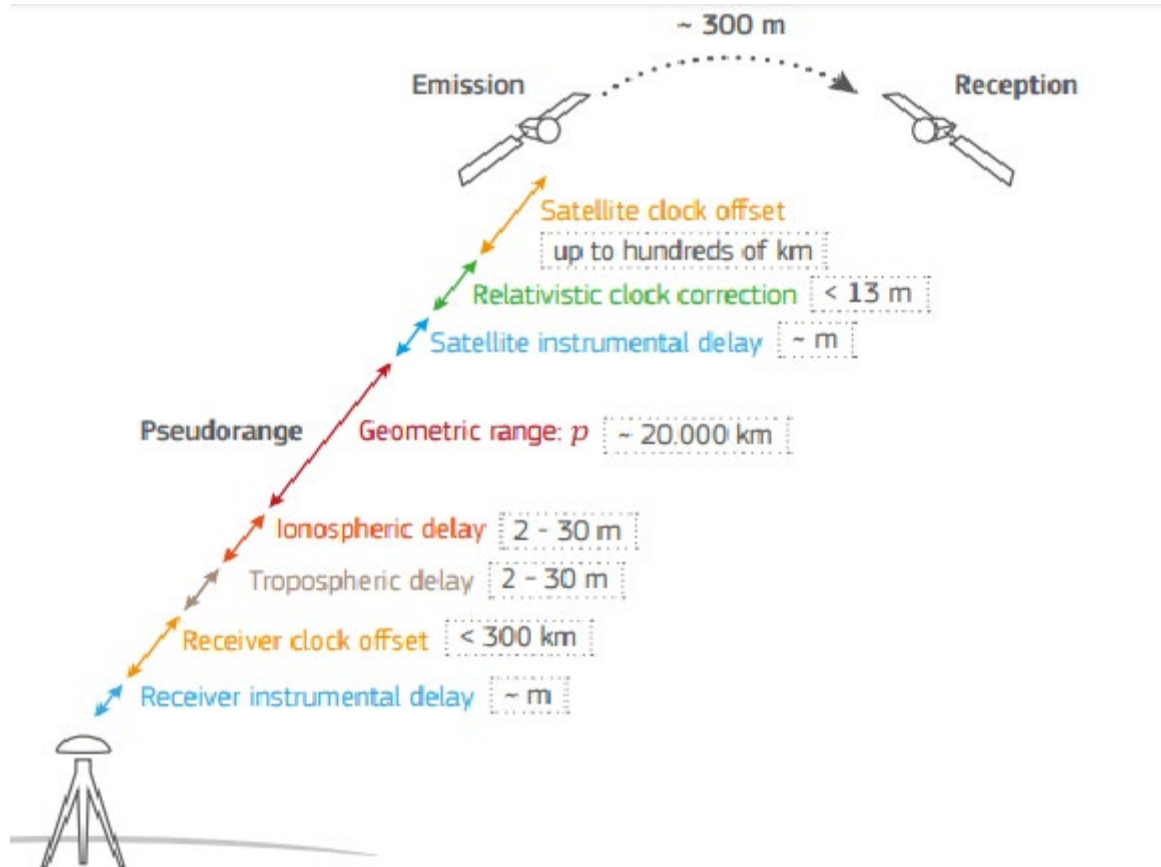

Figure 21. Pseudo-range generation

Multi-GNSS constellation

Multiple GNSS constellations can be used to solve the position solution. In harsh environments, a combination of multiple GNSS constellations can increase positioning accuracy. However, combining signals from different constellations in the PVT requires one to account for the time bias between the systems (Inter-System Bias, ISB). Otherwise, the range measurements will contain an additional error, thus degrading the position solution. One strategy is the use of a-priori knowledge of the ISB. For instance, thanks to Galileo's inter-system operability with GPS, the GPS to Galileo Time Offset (GGTO) is transmitted in the navigation message. It can be also provided to the user through assisted data. If the ISB is eliminated, the position solution can be computed for a single satellite navigation system. The ISB can be also be estimated by introducing it as an additional unknown parameter in the position equation. If all four systems (GPS, GLONASS, Galileo and BeiDou) are used for positioning, the three inter-system biases

between GLONASS, Galileo and BeiDou compared to GPS must be determined, resulting in the extended navigation equation [54]:

$$\begin{bmatrix} R^1 & - & \rho_0^1 \\ & \vdots & \\ R^n & - & \rho_0^n \end{bmatrix} = H \cdot \begin{bmatrix} d_x \\ d_y \\ d_z \\ c \cdot dt_r \\ c \cdot dt_{GPS/GLONASS} \\ c \cdot dt_{GPS/GALILEO} \\ c \cdot dt_{GPS/BEIDOU} \end{bmatrix}$$

Equation 23. Extended navigation

In this case, the range measurements of at least seven satellites are required. Note that this also impacts the actual Dilution of Precision (DOP) of the PVT solution, following the extra-State Theorem: The addition of an extra state to a least-squares problem makes all DOPs greater than or equal to their original values increasing the positioning error [54].

The Geometric Dilution of Precision (GDOP), indicates the distribution of satellites as shown below:

$$GDOP = \sqrt{\text{trace} \left[(H_{Los}^T H_{Los})^{-1} \right]}$$

$$H_{Los} = \begin{bmatrix} LOS_i^1 \\ \vdots \\ LOS_i^N \end{bmatrix}$$

Equation 24. GDOP distribution of satellites

A low GDOP indicates good GPS satellite coverage, which means that measurements are available in all directions, providing good observability of the state. Conversely, a large GDOP indicates poor coverage and may result in degraded estimates.

Appendix B

General view of software output

Below are the general figures for Matlab used in this study:

```

clear all
Start = cputime;
%1.07.2018 ВНИМАНИЕ При использовании файла с расширением "BIN",
полученного
%с помощью NovAtel Convert необходимо в функциях Read_Best и Read_RAIM2
% разблокировать строку oA = fread(fid,1,'uchar');
%Dat_In_GPS= 'In_date5\OEM719_13-12-2018_11-02-57.BIN'; %поставить oA
Dat_In_GPS= 'bestpos_raitm_25_10.gps';
fid = fopen(Dat_In_GPS,'rb');
% fw = fopen('Out_GPS_Dat\2015_02_19_GPS.txt','Wt');
%%%%%%%%%%%%%%%%%%%%%%%%%%%%%%%%%%%%%%%%%%%%%%%%%%%%%%%%%%%%%%%%%%%%%%%%
nameFigure =
'd:\MatLab_Programs\2017_RAIM_BEST_dipl\FigGLGALBDSQZSS\bestpos_raitm_25_10.
gps';%FigGLGALBDSQZSS
% filename1 = 'FigD\2018_10_12RMG1GalBDS QZ1';
% filename2 = 'FigD\2018_10_12RMG1GalBDS QZ2';
% filename3 = 'FigD\2018_10_12RMG1GalBDS QZ3';
% filename4 = 'FigD\2018_10_12RMG1GalBDS QZ4';
% filename5 = 'FigD\2018_10_12RMG1GalBDS QZ5';
% filename6 = 'FigD\2018_10_12RMG1GalBDS QZ6';
% filename7 = 'FigD\2018_10_12RMG1GalBDS QZ7';
filename1 = strcat(nameFigure,'1');
filename2 = strcat(nameFigure,'2');
filename3 = strcat(nameFigure,'3');
filename4 = strcat(nameFigure,'4');
filename5 = strcat(nameFigure,'5');
filename6 = strcat(nameFigure,'6');
filename7 = strcat(nameFigure,'7');
filename8 = strcat(nameFigure,'8');
filename9 = strcat(nameFigure,'9');
%%%%%%%%%%%%%%%%%%%%%%%%%%%%%%%%%%%%%%%%%%%%%%%%%%%%%%%%%%%%%%%%%%%%%%%%555
i = 0;
i1 = 0;
i2 = 0;
% for i = 1: 100
%for i = 1 : 28000
while (~feof(fid)) i = i + 1;
    Syn_c = fread(fid,3,'uchar') ; %B OEM-4 'Char'
    Hear_d= fread(fid,1,'uchar') ; %B OEM-4 'Uchar'
    Message_ID = fread(fid,1,'uint16') ; %B OEM-4 'Long'
    % fprintf('Message_ID =%i \n ',Message_ID);

    if Message_ID== 1286
        i1 = i1 + 1;
        [HPL(i1) VPL(i1) Time( i1)] = Read_RAIM2(fid);

    end

    if Message_ID== 42
        i2 =i2 + 1;

```

Appendices

```
[Lat(i2) Lon(i2) h(i2) Lat_sigma(i2) Lon_sigma(i2) h_sigma(i2)
TimeGPS(i2)] =...
    Read_Best(fid);

    end
end
% TimeGPS = TimeGPS(1:2:i2);
% plot(h), grid minor
% plot(VPL), grid minor
Gsigma = sqrt(Lat_sigma.^2+Lon_sigma.^2);% Прогноз приемника
% lat0 = mean(Lat);
% lon0 = mean(Lon);
% h0 = mean(h);
%Эталонные
lat0 = 50.4390605352;
lon0 = 30.4298715162;
h0 = 190.074;

spheroid = wgs84Ellipsoid('m');
[xEast,yNorth,zUp] = geodetic2enu(Lat, Lon, h, lat0, lon0, h0, spheroid);
HPE = sqrt(xEast.*xEast + yNorth.*yNorth);% Измерения
Vpe = abs(zUp);
    VAL1 = 12;
VAL2 = 20;
% sizxEast = length(xEast);
src_name='NAU';
% i1 = 5000;
    figure(1)%1
    vplstat(VPL(1: i1),Vpe(1: i1)',VAL1,VAL2, '628');
h = 1;
    saveas(h,filename1, 'bmp')
% saveas(figure,filename)

    figure(2)%2
HAL1= 20;
% HAL2=40;
    hplstat(HPL(1:i1),HPE(1: i1)',HAL1, src_name);
h = 2;
    saveas(h,filename2, 'bmp')

%%-----Скользящее окно. Смещение на 1 в слайде -----
nSlide = 1;
i=0;
ii = 0;
nn = 0; num = 0;
nSlide = 1;
sizeSlide = 100;

for i = 1 : length(HPL)
    if ii < sizeSlide
        ii = ii + 1;
        slideX(ii) = HPE(i);
        slideY(ii) = yNorth(i);
        slideZ(ii) = Vpe(i);
    else
        if nSlide > 1
            slideX(1:(sizeSlide-1)) = slideX(2 : sizeSlide);
            slideX(sizeSlide) = HPE(i);
            slideY(1:(sizeSlide-1)) = slideY(2 : sizeSlide);
```

```

        slideY(sizeSlide) = yNorth(i);
        slideZ(1:(sizeSlide-1)) = slideZ(2 : sizeSlide);
        slideZ(sizeSlide) = Vpe(i);
    end
end
if ii >= sizeSlide
    moX(nSlide) = mean(slideX);%HPE
    stdX(nSlide) = std(slideX);%HPE
    %
    %
    moY(nSlide) = mean(slideY);
    stdY(nSlide) = std(slideY);
    moZ(nSlide) = mean(slideZ);%VPe
    stdZ(nSlide) = std(slideZ); % Vpe
    %
    % [ MO, MSG, MSG0] = std_LK( sizeSlide, slideZ ); % MO =
0
    %
    % stdZ(nSlide) = MSG;

    nSlide = nSlide + 1;
end
% Выбрать поочередно участки из zU(i), размером sizeSlide (без
накладки)
%
% nn = nn + 1;
% dopZ(nn) = zUp(i);
%
% if nn == sizeSlide
%
% num = num + 1;
%
% [ MO, CKO_1, CKO_0 ] = std_LK( sizeSlide, dopZ );
%
% cko(num) = CKO_0;
%
% nn = 0;
%
% end
end
dT = 1 : nSlide - 1;
% dT = 1 : 5000;
s= 1;
titl = 'OEM719-15-12-2018-13-19-051';
figure(3) %12
yyaxis left
plot(dT, HPE(dT), 'b') % grid minor
ylabel ( 'HPE' )
yyaxis right
plot(dT, HPL(dT), 'r', 'LineWidth' , 2 ), grid on
ylim([0 40])
ylabel ( 'HPL' )
title(titl)
h = 3;
saveas(h,filename3, 'bmp')

figure(4) %12
yyaxis left
plot(dT, Vpe(dT), 'b') % grid minor
ylabel ( 'VPE' )
yyaxis right
plot(dT, VPL(dT), 'r', 'LineWidth' , 2 ), grid on
ylim([10 30])
ylabel ( 'VPL' )
title(titl)
h = 4;
saveas(h,filename4, 'bmp')

figure(5)
plot(dT,2*stdX(dT), 'b'),grid minor

```

Appendices

```
ylabel ( '2stdHPE')
title(titl)
h = 5;
saveas(h,filename5, 'bmp')
figure(6)
plot(dT, 2*stdZ(dT), 'b'),grid minor
ylabel ( '2stdV')
title(titl)
h = 6;
saveas(h,filename6, 'bmp')
figure(7)
plot(dT, 2*Gsigma(dT), 'b', dT,2*stdX, 'r', 'MarkerSize', 1),grid minor
ylabel ( '2stdRec, 2stdHPE')
title(titl)
h = 7;
saveas(h,filename7, 'bmp')

figure(8)
plot(dT, 2*h_sigma(dT), 'b', dT,2*stdZ, 'r', 'MarkerSize', 1),grid minor
ylabel ( '2stdRec, 2stdVPE')
title(titl)
h = 8;
saveas(h,filename8, 'bmp')

%%%%%%%%%%%%%%
figure(9)
plot(xEast(dT), yNorth(dT), 'bo', 'MarkerSize', 1),grid minor
% ylabel ( '2stdRec, 2stdVPE')
title(titl)
h = 9;
saveas(h,filename9, 'bmp')
%%%%%%%%%%%%%%5

Elapsed = cputime - Start;
sek =rem(Elapsed , 60);
min = fix(Elapsed / 60);
fprintf('Elapsed = %f cek\n', Elapsed);
fprintf('min = %3i ;   cek =%9.6f \n', min, sek);
```

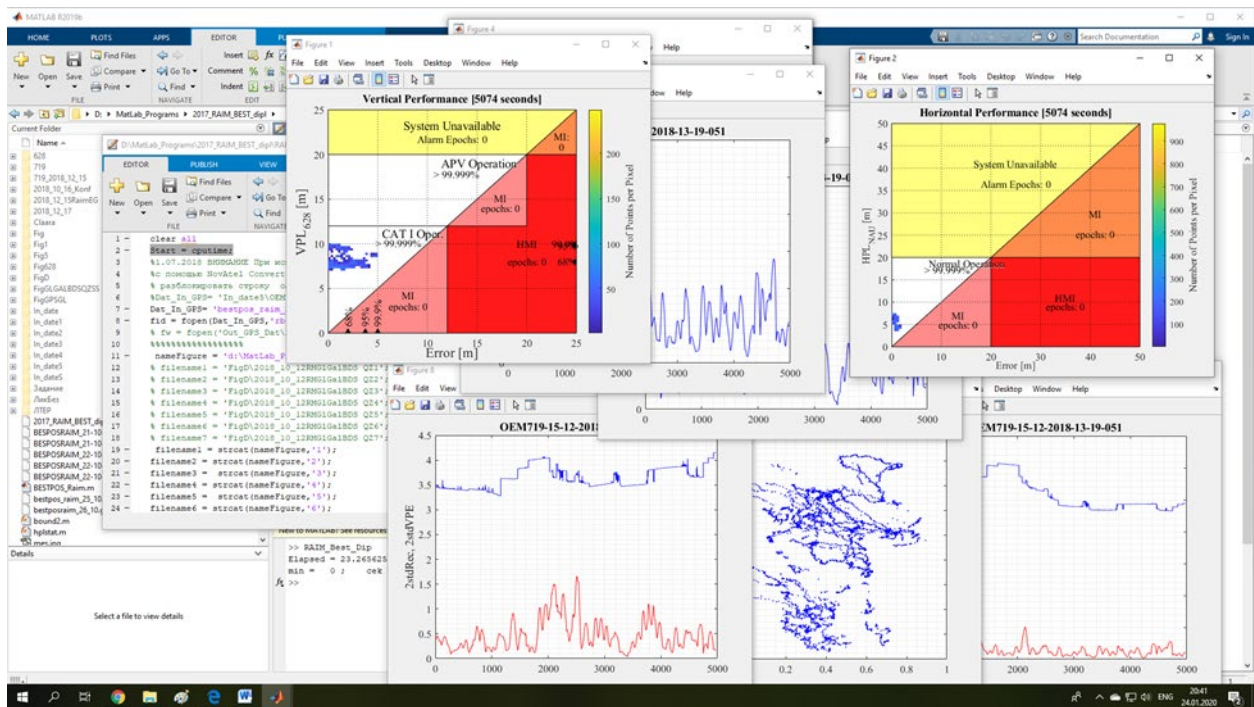

Figure 22. Stanford combined plots

General description of RAIMSTATUS and BESTPOS

RAIMSTATUS

RAIM stands for receiver autonomous integrity monitoring, a technology used in GNSS receivers to assess the integrity of the GNSS signals that are being received at any given time. It is particularly applicable to receivers intended for safety-critical applications, and in particular in aviation applications.

The RAIM concept makes use of redundant satellite signals – i.e., any that are available above and beyond those needed to produce a position fix. If the Pseudo-range data in any of the signals is at odds with the position computed from the other signals it may indicate a fault in that satellite, such as a clock error. Alternatively, the error may be due to unexpected atmospheric conditions.

In general, to obtain a 3D positional fix at least four satellite signals are required. To detect a fault, at least five signals are required, and to isolate and exclude a fault, at least six satellite signals are required. However, more signals are often needed, depending on the geometry of

the satellite constellation, and so RAIM is not always available. In aviation applications, pilots can check whether RAIM will be operational on any given route and/or approach by checking one or other of the RAIM prediction websites operated by the Federal Aviation Authority and Eurocontrol. These sites allow pilots to predict RAIM status during pre-flight checks [53].

Below is the table of the RAIMSTATUS descriptions followed in this study:

Table 7. RAIMSTATUS description

Field	Field Type	Description	Format	Binary Bytes	Binary Offset
1	RAIMSTATUS Header	Log header. See <i>Messages</i> on page 31 for more information.	-	H	0
2	RAIM Mode	RAIM mode (refer to <i>Table 54: RAIM Mode Types</i> on page 284)	Enum	4	H
3	Integrity status	Integrity Status (see <i>Table 116: Integrity Status</i> on the next page)	Enum	4	H+4
4	HPL status	Horizontal protection level status (see <i>Table 117: Protection Level Status</i> on the next page)	Enum	4	H+8
5	HPL	Horizontal protection level (m)	Double	8	H+12
6	VPL status	Vertical protection level status (see <i>Table 117: Protection Level Status</i> on the next page)	Enum	4	H+20
7	VPL	Vertical protection level (m)	Double	8	H+24
8	#SVs	Number of excluded satellites	Ulong	4	H+32
9	System	Satellite system (see <i>Table 102: Satellite System</i> on page 529)	Enum	4	H+36

10	Satellite ID	In binary logs, the satellite ID field is 4 bytes. The 2 lowest order bytes, interpreted as a USHORT, are the system identifier. For instance, the PRN for GPS or the slot for GLONASS. The 2 highest-order bytes are the frequency channel for GLONASS, interpreted as a SHORT and zero for all other systems. In ASCII and abbreviated ASCII logs, the satellite ID field is the system identifier. If the system is GLONASS and the frequency channel is not zero, then the signed channel is appended to the system identifier. For example, slot 13, frequency channel -2 is output as 13-2	Ulong	4	H+40
11	Next offset field = H+36+(#SVs * 8)				
12	xxxx	32-bit CRC (ASCII and Binary only)	Ulong	4	H+36 + (#SVs * 8)
13	[CR][LF]	Sentence terminator (ASCII only)			

BESTPOS

The BESTPOS log contains the best available position from either GNSS only, or GNSS/INS. BESTGPSPOS contains the best available GNSS position (without INS). Both logs have an identical format. In addition, it reports several status indicators, including differential age, which is useful in predicting anomalous behavior brought about by outages in differential corrections. A differential age of 0 indicates that no differential correction was used. Looking in the table below, it shown the bestpos solution descriptions

Table 8. BESTPOS description

Field	Field type	Description	Format	Binary Bytes	Binary Offset
1	BESTPOS header	Log header. See <i>Messages</i> on page 31 for more information.		H	0
2	sol stat	Solution status, see <i>Table 73: Solution Status</i> on the next page	Enum	4	H
3	pos type	Position type, see <i>Table 74: Position or Velocity Type</i> on page 417	Enum	4	H+4
4	lat	Latitude (degrees)	Double	8	H+8
5	lon	Longitude (degrees)	Double	8	H+16
6	hgt	Height above mean sea level (metres)	Double	8	H+24
7	undulation	<p>Undulation - the relationship between the geoid and the ellipsoid (m) of the chosen datum</p> <div style="border: 1px solid black; padding: 5px; margin: 5px 0;">  <p>When using a datum other than WGS84, the undulation value also includes the vertical shift due to differences between the datum in use and WGS84.</p> </div>	Float	4	H+32
8	datum id#	Datum ID number (see <i>Table 28: Datum Transformation Parameters</i> on page 119)	Enum	4	H+36
9	lat σ	Latitude standard deviation (m)	Float	4	H+40
10	lon σ	Longitude standard deviation (m)	Float	4	H+44
11	hgt σ	Height standard deviation (m)	Float	4	H+48
12	stn id	Base station ID	Char[4]	4	H+52
13	diff_age	Differential age in seconds	Float	4	H+56

14	sol_age	Solution age in seconds	Float	4	H+60
15	#SVs	Number of satellites tracked	Uchar	1	H+64
16	#solnSVs	Number of satellites used in solution	Uchar	1	H+65
17	#solnL1SVs	Number of satellites with L1/E1/B1 signals used in solution	Uchar	1	H+66
18	#solnMultiSVs	Number of satellites with multi-frequency signals used in solution	Uchar	1	H+67
19	Reserved		Hex	1	H+68
20	ext sol stat	Extended solution status (see <i>Table 77: Extended Solution Status</i> on page 420)	Hex	1	H+69
21	Galileo and BeiDou sig mask	Galileo and BeiDou signals used mask (see <i>Table 76: Galileo and BeiDou Signal-Used Mask</i> on page 420)	Hex	1	H+70
22	GPS and GLONASS sig mask	GPS and GLONASS signals used mask (see <i>Table 75: GPS and GLONASS Signal-Used Mask</i> on page 419)	Hex	1	H+71
23	xxxx	32-bit CRC (ASCII and Binary only)	Hex	4	H+72
24	[CR][LF]	Sentence terminator (ASCII only)	-	-	-

Table 9. Integrity monitoring

Phase of Flight	Accuracy (95% error)	Integrity		Alert Limit (H: Horizontal V: Vertical)	Continuity	Availability
		Time to Alert	Pr(HMI)			
LPV (APV1.5)	H: 16 m V: 20 m	10 sec	2×10^{-7} / approach	H: 40 m V: 50 m	5.5×10^{-5} / approach	0.99 to 0.99999
APV-2	H: 16 m V: 7.6 m	6 sec	2×10^{-7} / approach	H: 40 m V: 20 m	5.5×10^{-5} / approach	0.99 to 0.99999
CAT I	H: 16 m V: 4 to 7.6 m	6 sec	2×10^{-7} / approach	H: 40 m V: 10 to 12 m	5.5×10^{-5} / approach	0.99 to 0.99999
CAT II	H: 6.9 m V: 2.0 m	2 sec	2×10^{-9} / approach	H: 17.4 m V: 5.3 m	4×10^{-6} / 15 sec	0.99 to 0.99999
CAT III	H: 6.1 m V: 2.0 m	1 to 2 sec	2×10^{-9} / approach	H: 15.5 m V: 5.3 m	H: 2×10^{-6} / 30 sec V: 2×10^{-6} / 15 sec	0.99 to 0.99999

Appendix C

Stanford Plots

Below are plots from 18/12/19, of GPS simulation in a bad weather conditions

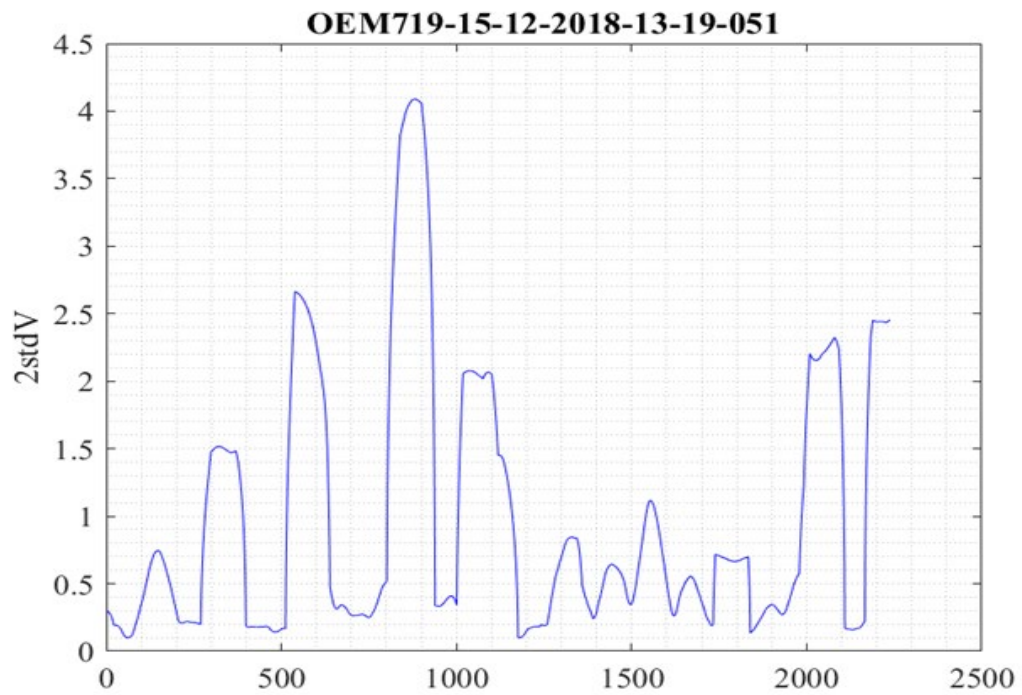

Figure 23. Standard Deviation

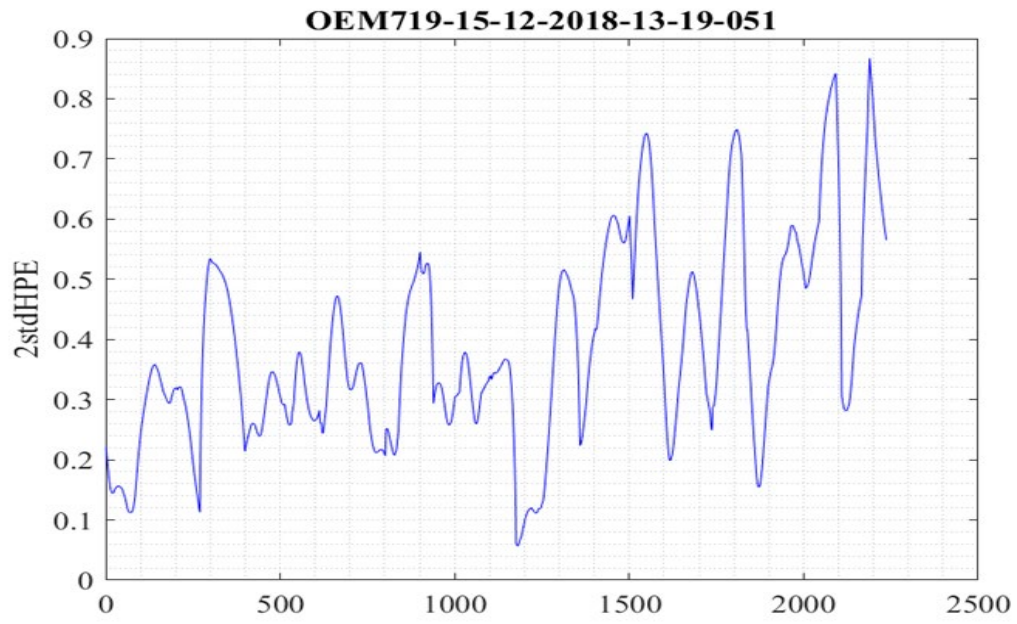

Figure 24. Standard deviation of HPE

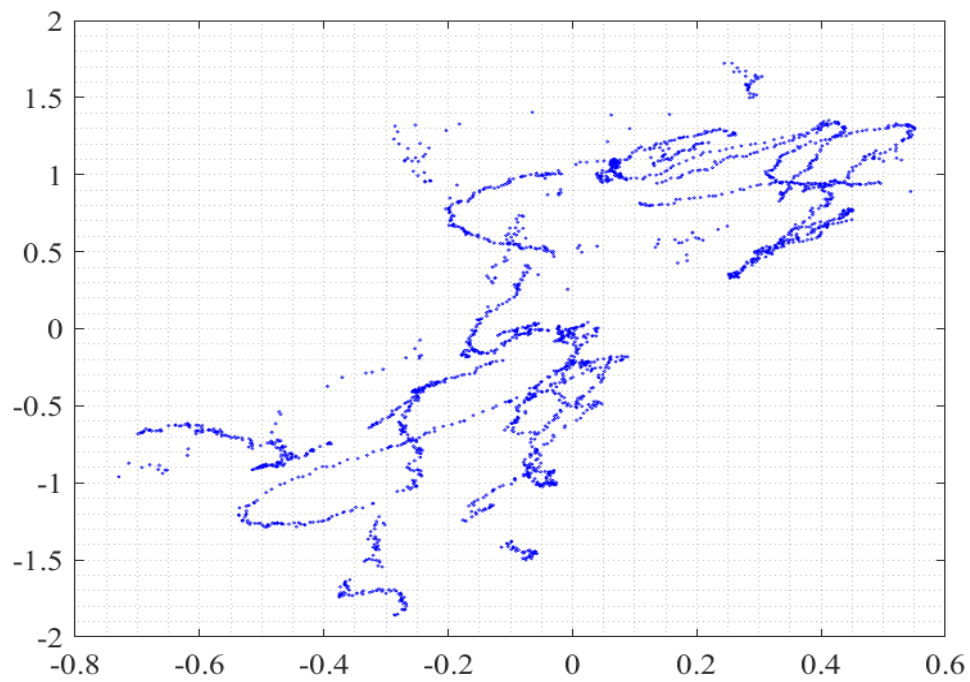

Figure 25. Distortion of errors

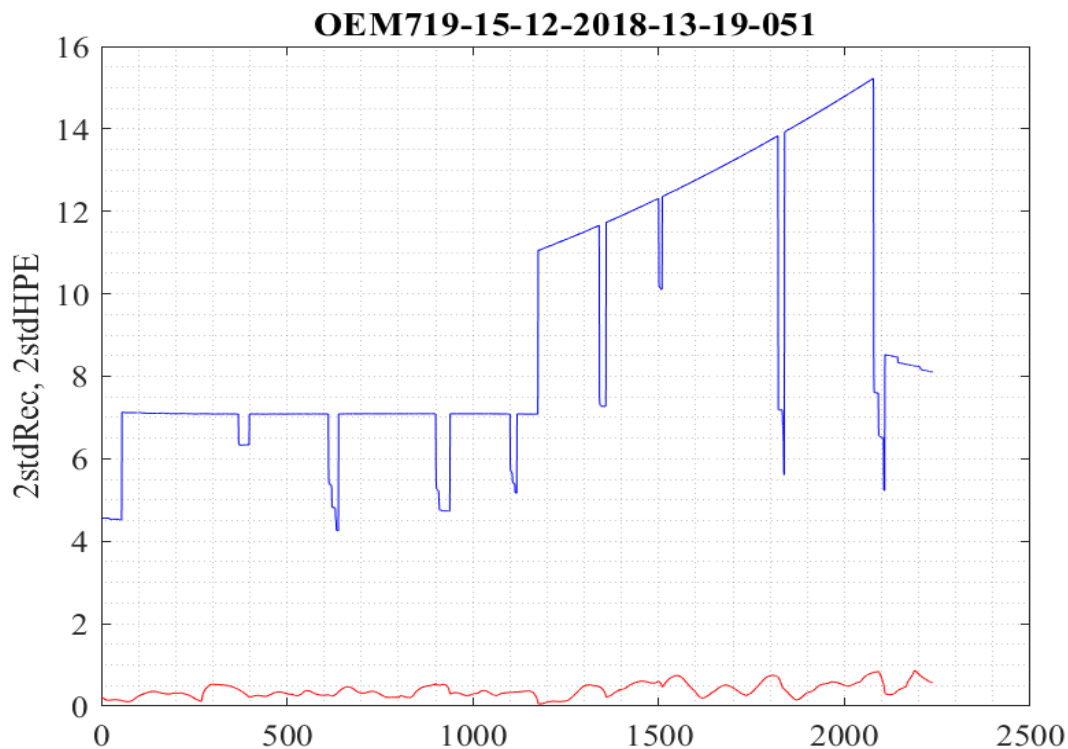

Figure 26. Second Standard deviation of HPE

Vertical and Horizontal Alert Limit cylinder are defined by the phase of flight

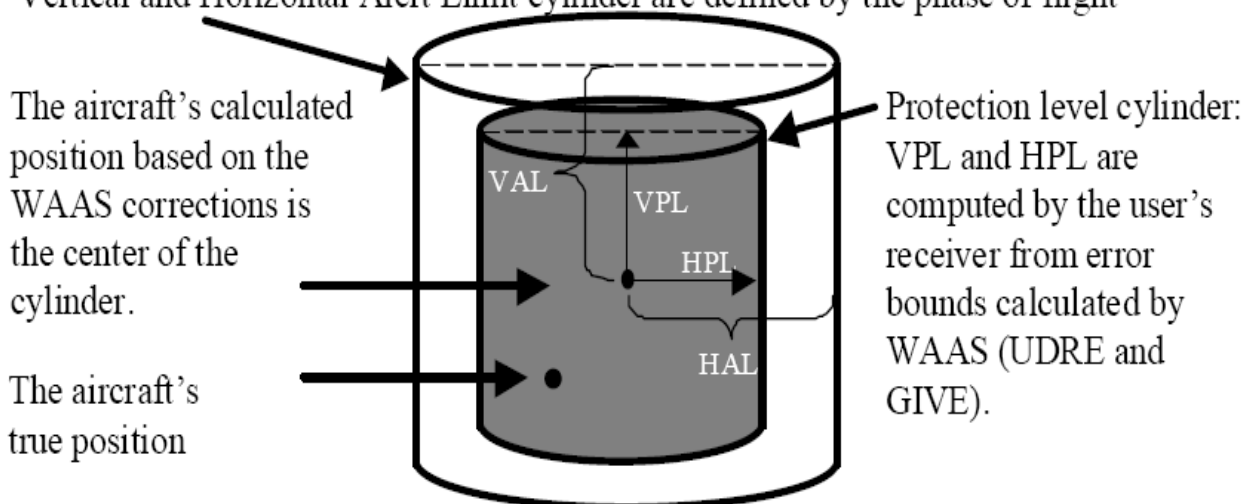

Figure 27. Protection Level cylinder

The Horizontal Protection Level (HPL) is the radius of a circle in the horizontal plane, with its centre being at the true position, which describes the region assured to contain the indicated

horizontal position. The Vertical Protection Level (VPL) is the half length of a segment on the vertical axis with its centre being at the true position, which describes the region assured to contain the indicated vertical position. In other words, the HPL bounds the horizontal position error with a confidence level derived from the integrity risk requirement. Similarly, the VPL bounds the Vertical Position Error. The figures show the daily evolution of the HPL and the VPL using fault free techniques for their computation. The number of used satellites in the computation is also shown

Table 10. Navigation Performance

	En Route	Terminal	LNAV	LNAV /VNAV	LPV	LPV 200
TTA	15 s	15 s	10 s	10 s	6.2 s	6.2 s
HAL	2 nm	1 nm	556 m	556 m	40 m	40 m
VAL	N/A	N/A	N/A	50 m	50 m	35 m
Probability of HMI	10^{-7} per hour	10^{-7} per hour	10^{-7} per hour	2×10^{-7} per approach	2×10^{-7} per approach (150 seconds)	2×10^{-7} per approach (150 seconds)
Zone 1 Continuity	$1 \cdot 10^{-5}$ per hour	$1 \cdot 10^{-5}$ per hour	$1 \cdot 10^{-5}$ per hour	$1-5.5 \times 10^{-5}$ /15 seconds	$1-8 \times 10^{-6}$ /15 seconds	$1-8 \times 10^{-6}$ /15 seconds
Horizontal Accuracy (95%)	0.4 nm	0.4 nm	220 m	220 m	16 m	16 m
Vertical Accuracy (95%)	N/A	N/A	N/A	20 m	20 m	4 m
Availability (Zone 1 Coverage)	0.99999 (100%)	0.99999 (100%)	0.99999 (100%)	0.99 (100%)	0.99 (80-100%)	0.99 (40-60%)
Availability (Zone 2 Coverage)	0.999 (100%)	.999 (100%)	.999 (100%)	.95 (75%)	0.95 (75%)	N/A
Availability (Zone 3 Coverage)	0.999 (100%)	.999 (100%)	.999 (100%)	N/A	N/A	N/A
Availability (Zone 4 Coverage)	0.999 (100%)	.999 (100%)	.999 (100%)	N/A	N/A	N/A
Availability (Zone 5 Coverage)	0.99999 (100%)	.999 (100%)	.999 (100%)	N/A	N/A	N/A

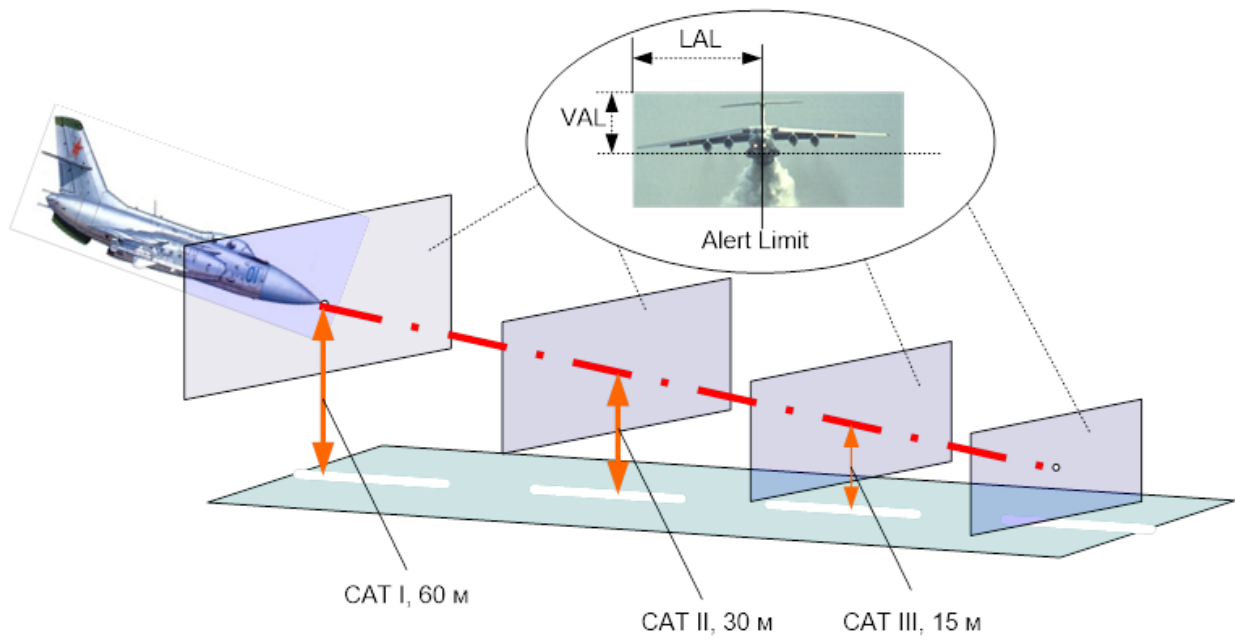

Figure 28. VAL and LAL demonstration

Below are plots from 16/01/20, of GPS +Galileo simulation in a bad weather conditions

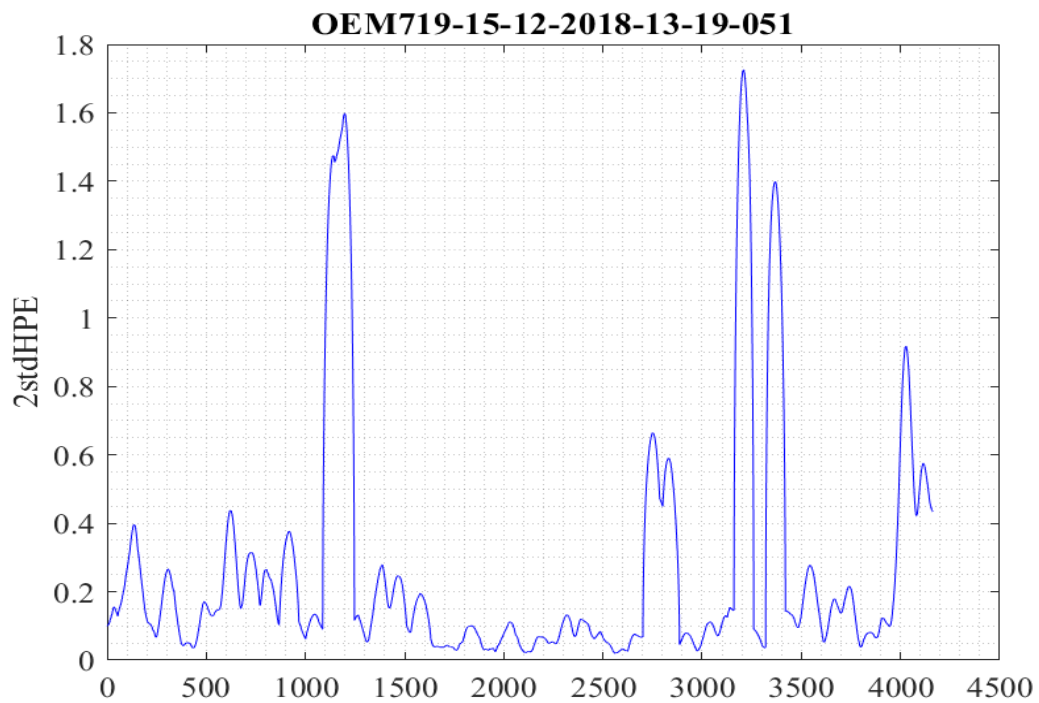

Figure 29. Standard deviation of HPE

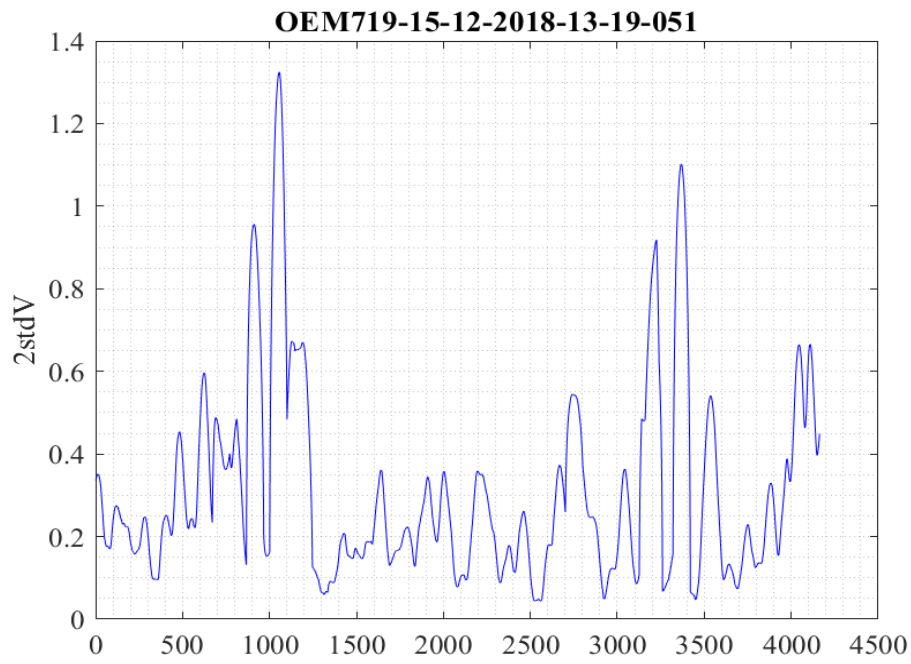

Figure 30. Standard deviation

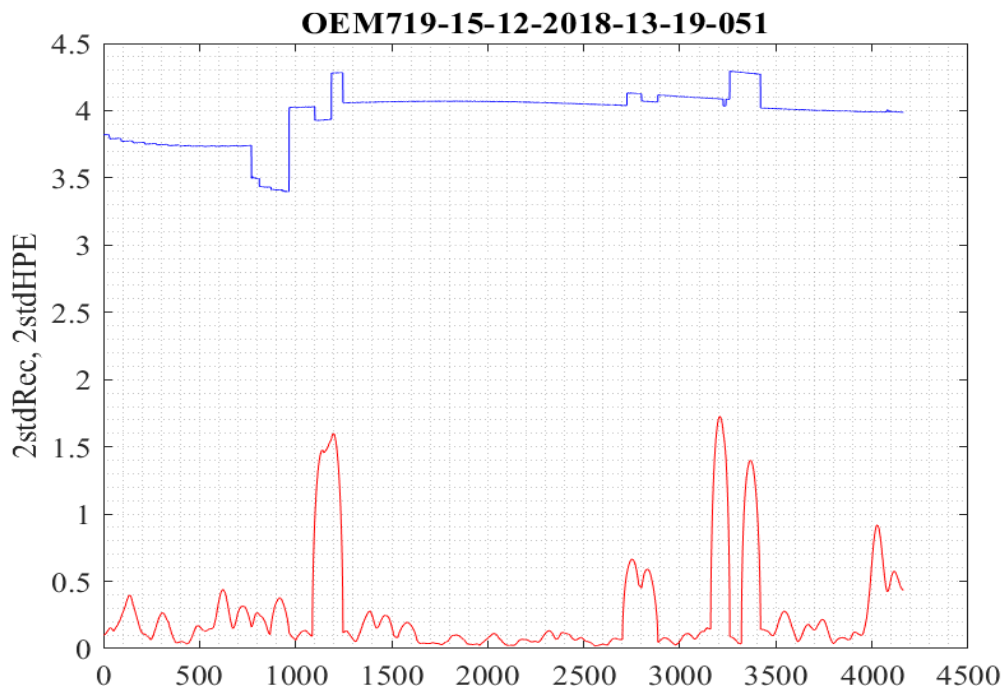

Figure 31. Second Standard deviation of HPE

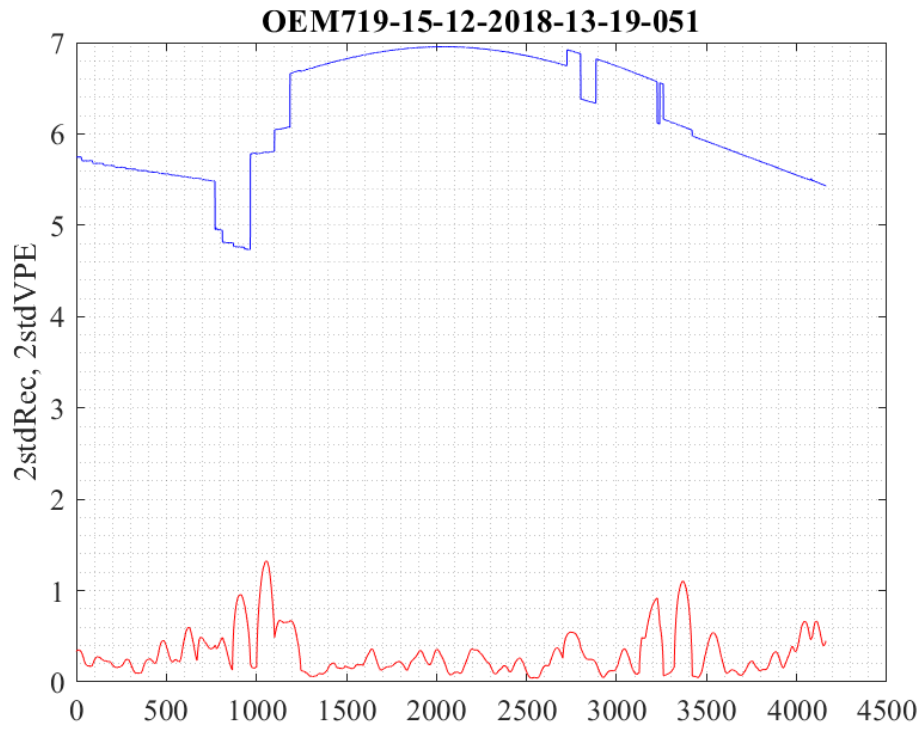

Figure 32. Second Standard deviation of VPE

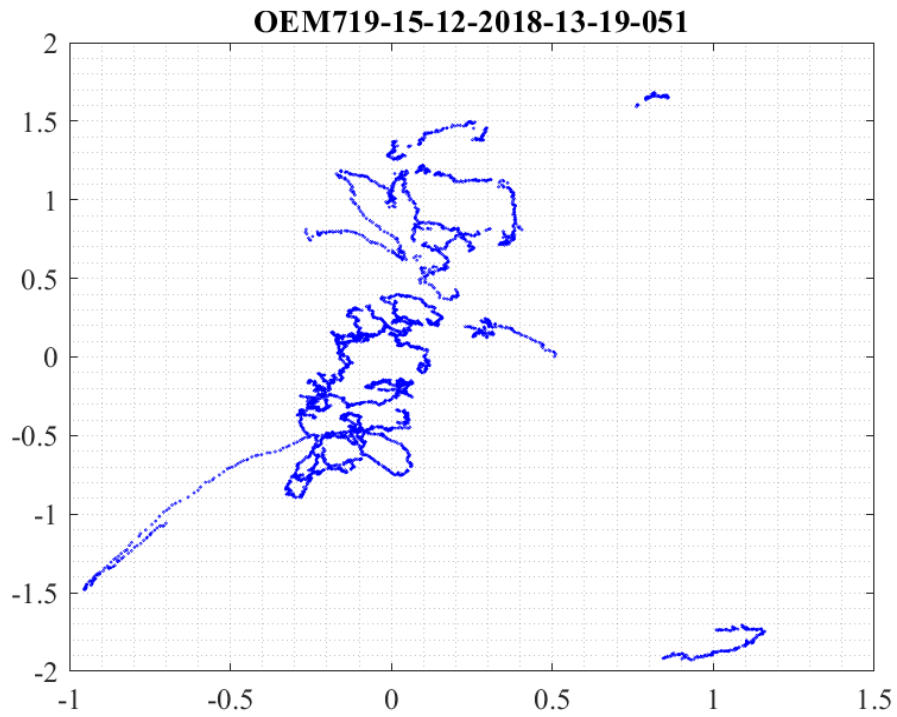

Figure 33. Distortion of errors

Appendix D

Troposphere and Ionosphere Algorithm

Atmospheric can be monitor by using ionosonde (for ionosphere) and Automatic Weather Station (for troposphere), however, in accordance with the emergence and the development of GNSS (Global Navigation Satellite System) technology and methods, it leads to diverse application of GNSS, such as ionosphere and troposphere monitoring. As the GNSS signals transmitted through the atmosphere, the GNSS signals are interfered by the TEC (Total Electron Content) in the ionosphere, while water vapor in the troposphere [53].

By understanding the GNSS signal propagation, TEC and water vapor can be estimated. Geometrical linear combination of GNSS signal is used to determine the TEC, while PPP (Precise Point Positioning) method is used to determine the tropospheric delay which lead to water vapor estimation [54]

GNSS Ionospheric Algorithm

The Slant TEC is defined as the line integral of the electron density from all GNSS-Satellites visible from each of these receiver above a user-specified elevation cut-off angle (usually 15degrees). Mathematically, slant TEC can be defined as follows [54]:

$$STEC = \int Ne(r)dl = \frac{[P_1 - P_2] - [RCB - SCB]}{\frac{C_x}{2} \left[\frac{1}{f_1^2} - \frac{1}{f_2^2} \right]}$$

Equation 25. GNSS Ionosphere Algorithm

Where:

C_x : Constant 80.62

RCB : Receiver code bias/receiver clock bias

SCB : Satellite code bias/satellite clock bias

P : Pseudo-range

f : Frequency

GNSS Tropospheric Algorithm

Tropospheric parameter can be determined by Precise Point Positioning (PPP) algorithm. PPP uses both of Pseudo-range and carrier phase GNSS observation data from a single dual-frequency receiver. PPP can be simply and combined tropospheric mapping function [54]:

$$P_{IF} = \frac{[f_1^2 P_1 - f_2^2 P_2]}{f_1^2 - f_2^2} = \rho + Cdt + mf \cdot Zdt + \vartheta P_{IF}$$

Equation 26. GNSS Tropospheric Algorithm

Where:

mf : tropospheric mapping function

Zdt : Refer to zenith troposphere delay

P : Pseudo-range

f : Frequency

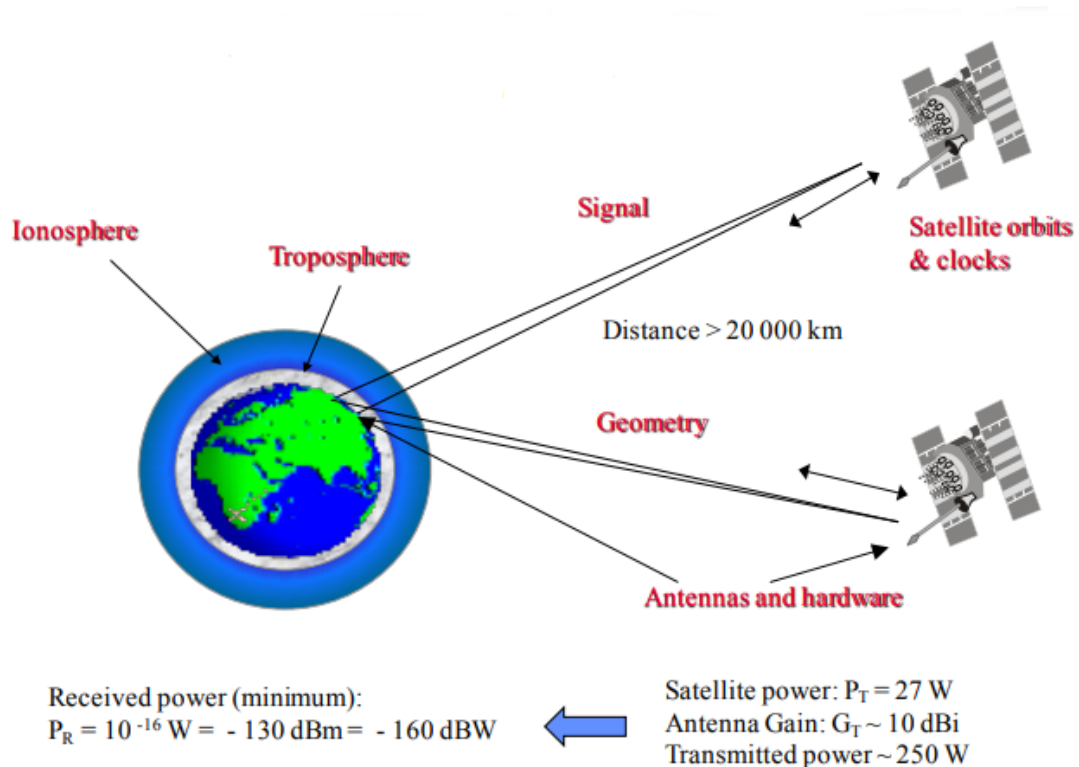

Figure 34. Ionosphere and Troposphere demonstration

Appendix E

Final Approach of Aircraft

Having the following, the final approach can be reached, some mathematics calculations are present to achieve this stage manual,

- Airspeed indicator,
- Altimeter,
- Vertical velocity indicator,
- Attitude indicator.

Cockpit view and all the gadgets available



Figure 35. Cockpit view

Some Mathematics calculations are present below

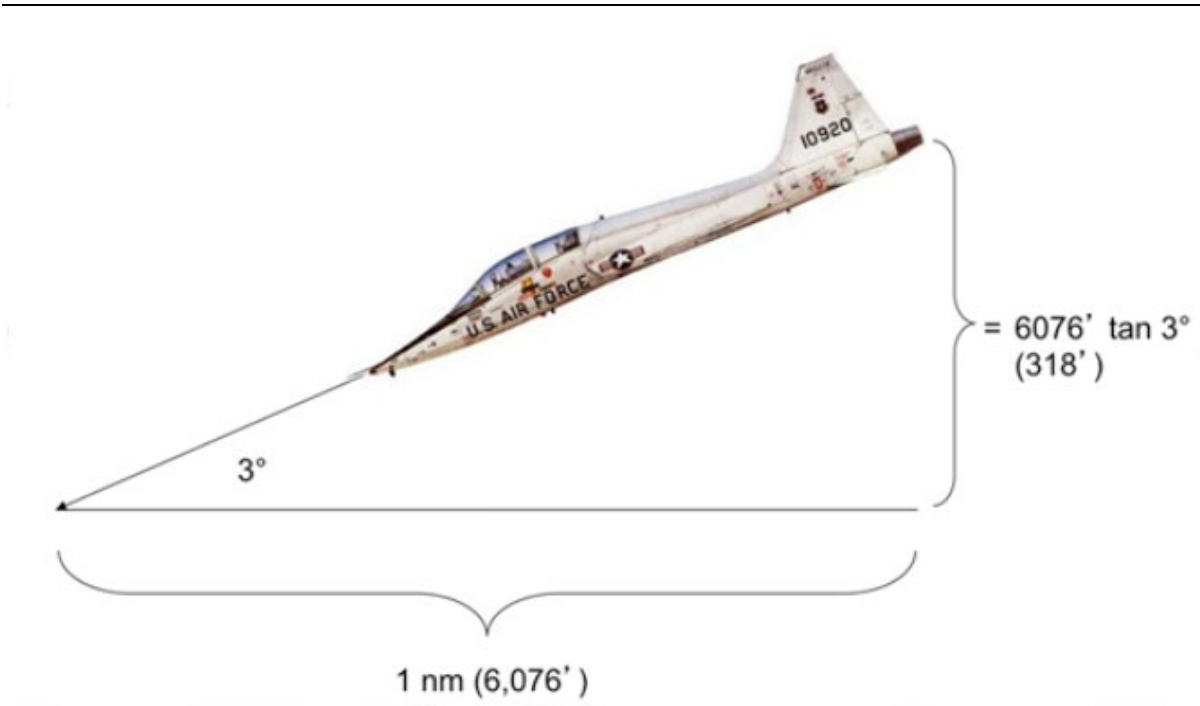

Figure 36. Glide path

Height per Distance

$$H = 6076(\tan 3^\circ) = 318ft$$

Taking T-38 as an example flying a final approach speed of 160 knots worked out to around 800 fpm VVI

$$V = \left(160 \frac{nm}{hour}\right) \times \frac{1 hour}{60 min} = 2.67 \frac{nm}{min}$$

$$time\ to\ travel\ 1nm = \frac{d}{v} = \frac{1nm}{2.6\ nm/min} = 0.38\ min$$

Equation 27. Final approach Speed

The equation for VVI writes itself:

$$VV = \frac{d}{t} = \frac{3.18ft}{0.38min} = 836\ ft/min$$

Equation 28. Vertical Velocity Indicator

So the rule of thumb is backed up by the math, but strangely it didn't always work. After a few years of practice, it became clear the reason was wind. Using ground speed instead of indicated speed fixed everything

The Rule of Thumb

“A 3 degree glide path descent rate in feet/minute is equal to one-half the ground speed in nm/hour, multiplied by ten”

Down to Earth example

Not many airplanes fly an approach at 160 knots, granted. So here are a few examples

- Boeing 747 — 140 knots, 10 knot headwind: $\left[\frac{(140-10)}{2}\right] \times 10 = 650 fpm$
- T-37B — 110 knots, 10 knot headwind: $\left[\frac{(110-10)}{2}\right] \times 10 = 500 fpm$