

INVESTIGATION OF TRAFFIC ACCIDENT: GATE DEFORMATIONS DURING MOTOR VEHICLE-GATE INTERACTION

**Olegas Prentkovskis¹, Andrey Beljatynskij², Rasa Prentkovskienė³,
Ona Lukoševičienė⁴, Edgar Sokolovskij⁵**

^{1, 3, 4, 5} Vilnius Gediminas Technical University
Faculty of Transport Engineering

^{1, 3} Dept of Transport Technological Equipment
Plytinės g. 27, LT-10105 Vilnius, Lithuania

^{4, 5} Dept of Automobile Transport
J. Basanavičiaus g. 28, LT-03224 Vilnius, Lithuania

² National Aviation University
Institute of Municipal Activity

Dept of Airport Reconstruction and Automobile Roads
Kosmonavta Komarova ave 1, 03680 Kiev, Ukraine

E-mails: ¹olegas@ti.vgtu.lt; ²beljatynskij@mail.ru; ³rasa@ti.vgtu.lt; ⁴tiauto@ti.vgtu.lt;
⁵edgar.sokolovskij@ti.vgtu.lt

Statistical data of registered traffic accidents in Lithuania is presented. The specific traffic accident investigated using the mathematical model of transport and pedestrian traffic restricting gate which is designed and briefly presented in paper. There are two sections of the gate: first section restricted the traffic of motor vehicles, second section limited the traffic of pedestrians. The gate was modelled based on the first-order one-dimensional finite elements taking into account only the resilience of the gate elements and the impact of soil on the ground-embedded parts of the gate support and auxiliary posts. The deformations of gate elements were determined based on the mathematical model designed. The computer-run simulation (for the purpose of working out the mathematical model of gate) was performed using specially developed *Maple* and *Compaq Visual Fortran Professional* software-based applied programs.

Keywords: traffic accident, motor vehicle, interaction, gate, finite elements, deformation, computer-run simulation

1. Introduction

A motor vehicle is the most comfortable and popular means of transport; however, it causes a lot of problems for all road users.

Traffic accidents occur every 15 seconds, in which people suffer. One person is injured every 1.5 minute, i.e. one thousand people are injured during 24 hours. Thus, one million inhabitants of the Earth are lost in the period of three years [1]. The number of old motor vehicles exceeding its own resources several times has increased in Lithuania. Following statistics, one person is killed every 8 hours, and one person is injured each hour on Lithuanian roads [1].

Each year approximately 6200 registered traffic accidents occur in Lithuania (Figure 1) [2]. The types of accidents vary. To study accidents of various types accurately, first of all, the universal dynamic model of the motor vehicle as well as the model of the road and various obstacles shall be constructed [1, 3–5].

In order to restrict the incoming/outgoing traffic of motor vehicles to/from a particular private or safeguarded territory, there being used various gates installed in yards as well as in streets or on automobile roads. The preferences of natural persons and legal entities for one or another type and style of yard gates depend on the trends and demands prompted by the modern style of life. Anyway, whether simple or highly sophisticated, all gates perform the same function – they open or close access to private estates or safeguarded areas. The gates themselves may be made of wood, metal, plastic or a combination of these (Figure 2) [3, 6].

A gate, though viewed as an obstacle subject to deformation, is not attributed to the category of road guardrails even if the structure of some gates could be assumed, based on visual judgment, as corresponding to that of road guardrails. The function of road guardrails is to reduce the probability of motor vehicle violating the traffic by keeping it within the limits of roadway and by guiding its travel along the longitudinal axis of the guardrail and/or fully stopping it [3–5]. To enable the aforementioned functions, the guardrails are designed in such a way as to ensure full or partial absorption of a motor vehicle kinetic energy thanks to the deformation of guardrail structural elements occurring at certain specific accelerations developed during an impact. Thus, as mentioned before, the function of deforming gates is to restrict transport and pedestrian traffic.

The deformations of gate elements may be investigated using the same simulation models and software as employed for testing the deformation properties exhibited by the elements of road guardrails. The models designed for investigating the deformations of beam guardrail systems may be also successfully applied. Further the paper presents the case-study of a particular traffic accident which took place in one of the Lithuanian cities.

As claimed by the participants and witnesses of the traffic accident, the motor vehicle did crash into the gate erected at the end of the street to restrict the incoming traffic of motor vehicles and pedestrians to a particular territory.

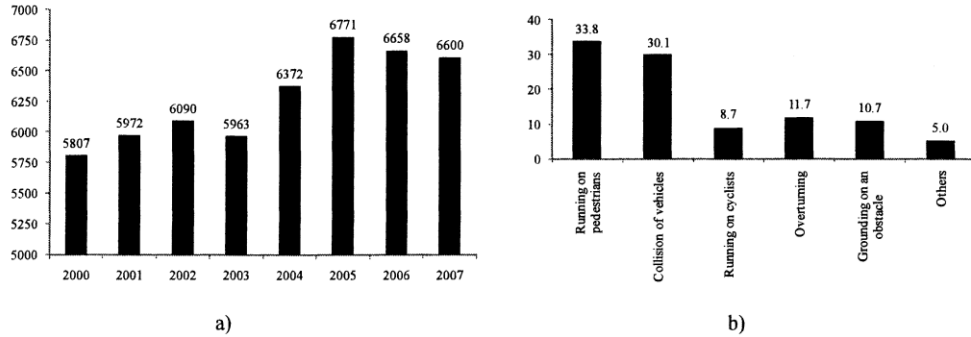

Figure 1. Statistical data of registered traffic accidents in Lithuania:
 a – dynamics of traffic accidents in 2000–2007; b – distribution of traffic accidents by type in 2007

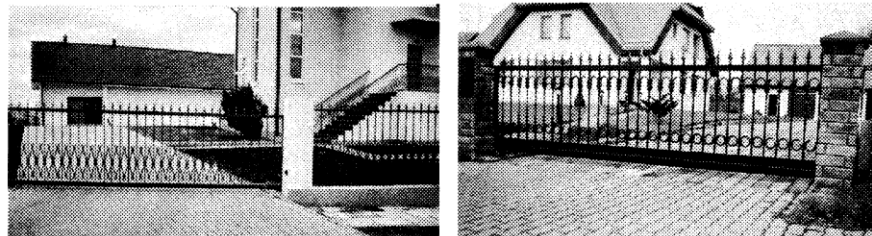

Figure 2. The gates erected to restrict transport and pedestrian traffic

Worldwide, there exists a great variety of mathematical models and software developed specially for the purpose of investigating deformations of various structural elements [1, 3–5, 7–10]. As noted before, the models designed for testing the deformations of road guardrail and beam guardrail system elements appear to be most suitable for testing the deformation properties of gate elements, too. The studies covered in the above overview, however, represent only a very small share of all the extensive research efforts existing world-wide and devoted to herein addressed subject. Some studies are conducted using very costly hardware and software whereas others require the performance of ordered on-scene experiments which, too, are very expensive. The authors of this publication tried to carry out the investigation of the selected traffic accident and the analysis of potential deformations on the elements of transport and pedestrian traffic restricting gates developed during motor vehicle–gate interaction as least-cost and accurate as possible. The models applied for investigating this particular case are presented in the [1, 3–5] papers.

2. Brief Review of Traffic Accident

As it was mentioned in Introduction, the particular traffic accident took place in one of the Lithuanian cities. While examining the traffic accident, the authors of this publication identified the presence of some contradictory facts. On the street road concerned, there was installed a gate restricting the traffic of motor vehicles and pedestrians. The scheme of the gate is presented in Figure 3. The gate was of the type which could rotate around the pivot of the gate support post and rest against the auxiliary post while in closed position. The gate support and auxiliary posts were erected on the street pavements (Figure 4).

One section of the gate (the longer one) restricted the traffic of motor vehicles while the other (the shorter one) limited the traffic of pedestrians. Neither the gate nor the posts were found in place after the traffic accident. Later, the gates were found and they appeared to contain some queer deformations. The section restricting the traffic of motor vehicles was found with its arch symmetrically deformed (Figure 5). The ground-embedded remains of the posts stayed in place but the posts themselves were missing producing the effect as if they had been accurately truncated (they were not found on the scene). The section of the gate which restricted the traffic of pedestrians was not found, either.

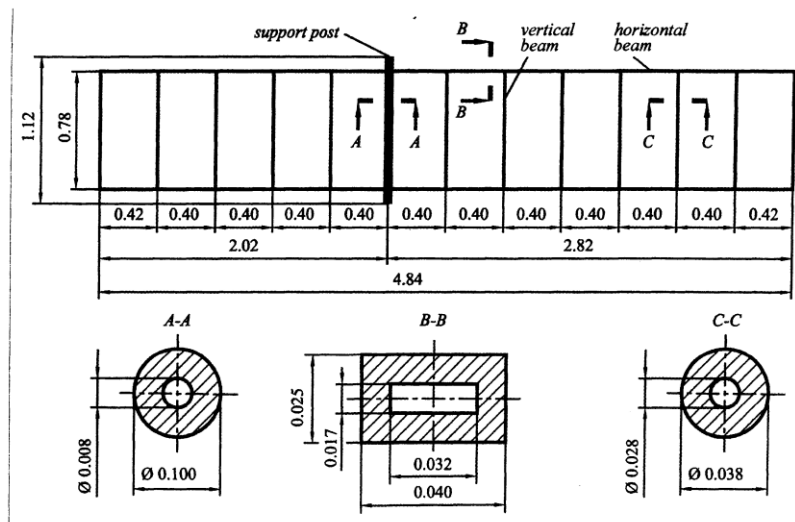

Figure 3. The scheme of the investigated gate

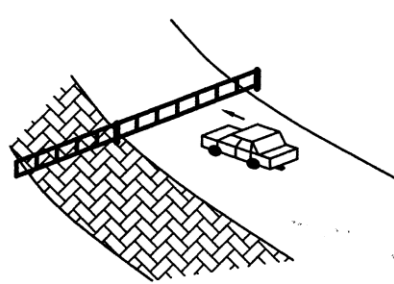

Figure 4. The scheme of motor vehicle-gate imaginary interaction (the gate is tightly closed)

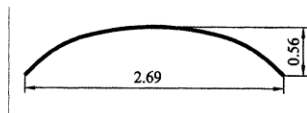

Figure 5. Deformations identified on the section of gate which restricts the traffic of motor vehicles (the top-view, only left side of horizontal beams from support post are deformed, vertical beams are not deformed)

3. Mathematical Model of Gate

The potential deformations of gate elements were investigated using the Finite Element Method. The mathematical gate model was developed based on the mathematical model of road guardrail [3, 4].

The gates were modelled using the first-order one-dimensional finite elements (Figure 6) [1, 3, 4]. At the moment of an impact, the nodes of finite elements change their position within the system of $X - Y - Z$ coordinates (a gate develops deformations). Therefore, while modelling, only the resilience of gate elements as well as soil impact upon the ground-embedded parts of the gate support and auxiliary posts were taken into consideration [3, 4].

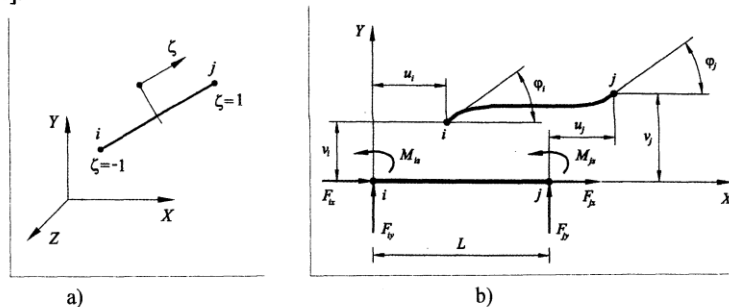

Figure 6. The first-order one-dimensional finite element:
a – the scheme within the system of $X - Y - Z$ coordinates; b – the deformations on $X - Y$ plane

Since a gate is a mechanical system, the system of finite element movement equations was drawn based on the Lagrangian second-order equations [3, 4].

4. Outcomes of Computer-Run Simulation

The computer-run simulation was performed on a personal computer using the *Maple* [11] and *Compaq Visual Fortran* software [12]. The matrixes of finite element masses, mechanical energy damping and stiffness were generated in the *Maple* software environment whereas the mathematical model of gate was developed using the *Compaq Visual Fortran* software. As noted before, the mathematical model was designed specially for the purpose of investigating the particular traffic accident. We determined the force of impact upon the gate F_{gate} based on the available speed value of the motor vehicle concerned and then added this force at certain nodes of the gate finite elements [3].

The situations of motor vehicle–gate interaction (Figure 4) were simulated and investigated, the computational scheme and the outcomes of computer-run simulation are presented in Figure 7:

- the motor vehicle and the horizontal beam of the gate interact on the horizontal plane along the transverse axis of the gate;
- the motor vehicle and the vertical beam of the gate (fixed between the two horizontal beams) interact on the vertical plane along the transverse axis of the gate.

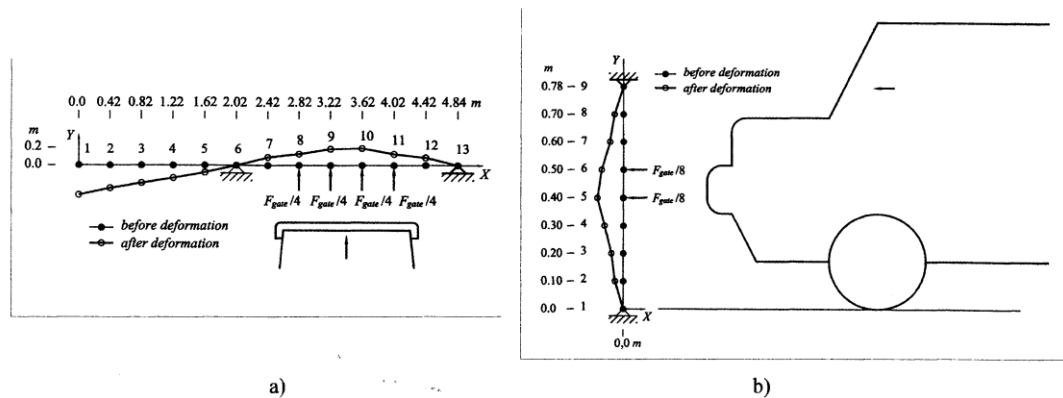

Figure 7. The computational scheme and the outcomes of computer-run simulation

Conclusions

- The mathematical model of transport and pedestrian traffic restricting gate is designed. The gate was modelled based on the first-order one-dimensional finite elements taking into account only the resilience of the gate elements and the impact of soil on the ground-embedded parts of the gate support and auxiliary posts.
- The specific traffic accident was investigated using the mathematical model of gate designed. The potential deformations of gate elements were determined based on the mathematical model designed. Based on the investigation results, it was concluded that the impact of motor vehicle on the gate had not actually occurred.
- The mathematical model of gate presented may be applied (alone or in combination with other models) for investigating and simulating other traffic accidents, too.

References

- Baublys, A., Bogdevičius, M., Prentkovskis, O. et al. *Transport: technologies, economics, environment, health: Monograph (Transportas: technologijos, ekonomika, aplinka, sveikata: monografija)*, 2003, 876 p. (Vilnius, Technika, in Lithuanian).
- Website of the Lithuanian Road Administration under the Ministry of Transport and Communications of the Republic of Lithuania – www.lra.lt
- Prentkovskis, O., Prentkovskienė, R., Lukoševičienė, O. Investigation of potential deformations developed by elements of transport and pedestrian traffic restricting gates during motor vehicle–gate interaction, *Transport*, Vol 22, No 3, 2007, pp. 229-235. (Vilnius, Technika).
- Bogdevičius, M., Prentkovskis, O. Simulation of road guardrails, *Transport*, Vol 16, No 4, 2001, pp. 123–128. (Vilnius, Technika).

5. Bogdevičius, M., Prentkovskis, O., Vladimirov, O. Engineering solutions of traffic safety problems of road transport, *Transport*, Vol 19, No 1, 2004, pp. 43–50. (Vilnius, Technika).
6. Website of Company "Eurolaikas" – www.eurolaikas.lt
7. Bank, L. C., Yin, J., Gentry, T. R. Pendulum impact tests on steel W-beam guardrails, *Journal of Transportation Engineering*, Vol 124, No 4, July/August 1998, pp. 319–325.
8. Coon, B. A., Reid, J. D. Crash reconstruction technique for longitudinal barriers, *Journal of Transportation Engineering*, Vol 131, No 1, January 2005, p. 54–62.
9. Kokkula, S., Hopperstad, O. S., Lademo, O.-G., Berstad, T., Langseth, M. Offset impact behavior of bumper beam-longitudinal systems: numerical simulations, *International Journal of Crashworthiness*, Vol 11, No 4, 2006, pp. 317–336.
10. Polivka, K. A., Coon, B. A., Sicking, D. L. et al. Midwest guardrail system W-beam to Thrie-beam transition. In: *TRB 86th Annual Meeting Compendium of Papers CD-ROM* (Transportation Research Board Annual Meeting 2007, Paper No. 07-2628), 2007, 20 p.
11. Aladjev, V., Bogdevičius, M., Prentkovskis, O. *New software for mathematical package Maple of releases 6, 7 and 8: Monograph*, 2002. 404 p. (Vilnius, Technika).
12. Schick, W., Silverman, G. *Fortran 90 and engineering computation*, 1995, 425 p. (John Wiley & Sons).